

DO NOT SCALE DRAWING

☒ LOCATION FOR IMPACT TEST SPECIFICATION—LENGTHS TO 3/8"

DRAWN FOR

BY DDS DESIGNS

"OUR NAME SAYS IT ALL"

- 1) MATERIAL RIGID PVC
- 2) CAPSTOCK
- 3) UNSPECIFIED WALLS
- 4) BREAK ALL CORNERS
- 5) AREA SQ. IN.
- 6) WT/FT LBS/FT

TITLE CW300 WELD MAIN FRAME/WELDED SASH				
DWN BY DDS	SCALE	DATE 02/28/12	CHKD BY	APPD BY
COMPUTER NO				
DWG NO CW300 CROSS SECTION				

NO.	REVISION	BY	DATE

CASEMENT WELDED MF & SASH

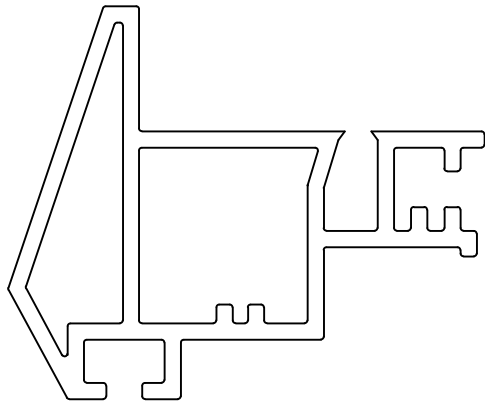

5000  
CASEMENT SASH  
WELDED

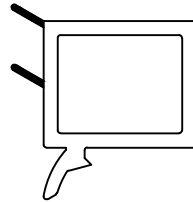

5008  
CASEMENT GLAZING BEAD  
WELDED

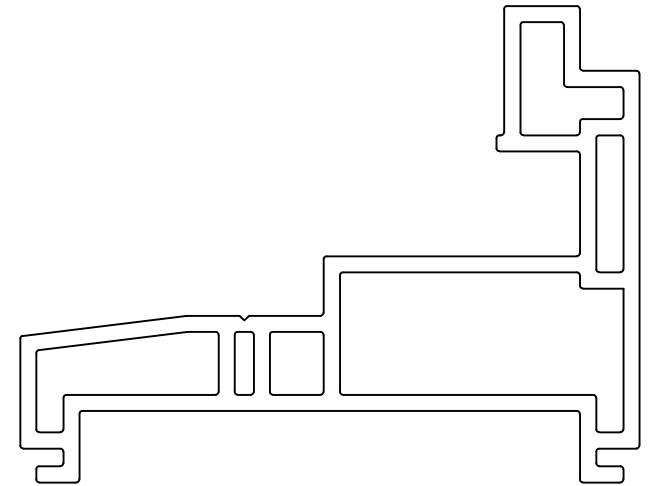

5012  
CASEMENT MAIN FRAME  
WELDED

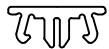

710  
SNAP IN MULLION

DRAWN FOR  QUALITY LINEALS BY DDS DESIGNS "OUR NAME SAYS IT ALL"	TITLE CASEMENT WELDED MF & SASH				
	DWN BY DDS	SCALE	DATE 09-2-11	CHKD BY	APPD BY
	COMPUTER NO				
DWG NO		C- REPLACEMENT CASEMENT			

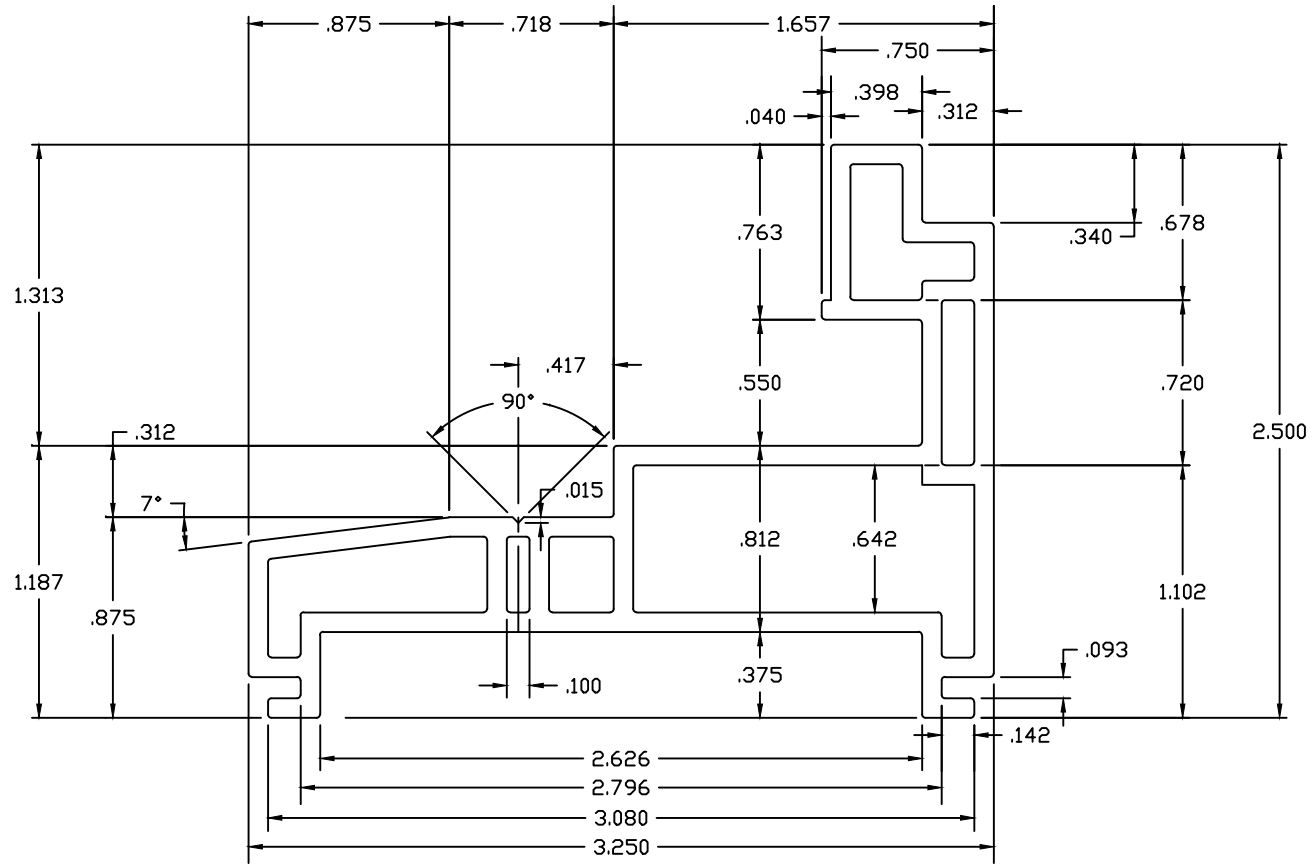

DO NOT SCALE DRAWING

☒ LOCATION FOR IMPACT TEST SPECIFICATION—LENGTHS TO 3/8" ALLOWABLE BOW MAX. 1" PER 14' ANGULARITY TO BE ± 1/2

DRAWN FOR



BY  DDS DESIGNS

"OUR NAME SAYS IT ALL"

- 1) MATERIAL RIGID PVC
- 2) CAPSTOCK
- 3) UNSPECIFIED WALLS .080
- 4) BREAK ALL CORNERS .015 R
- 5) AREA 1.192 SQ.IN.
- 6) WT/FT LBS/FT

TITLE CASEMENT WINDOW CSMT MAIN FRAME

DWN BY DDS	SCALE 2:1	DATE 11/14/02	CHKD BY	APPD BY
---------------	--------------	------------------	---------	---------

COMPUTER NO

DWG NO 5012

NO.	REVISION	BY	DATE	

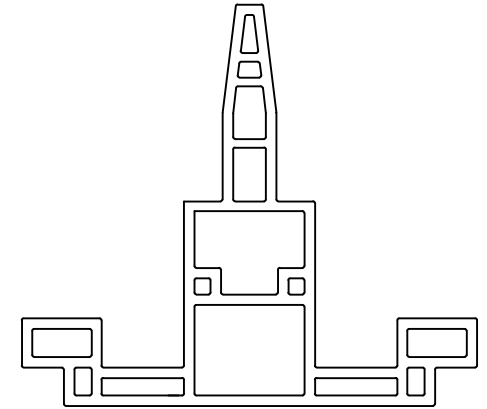
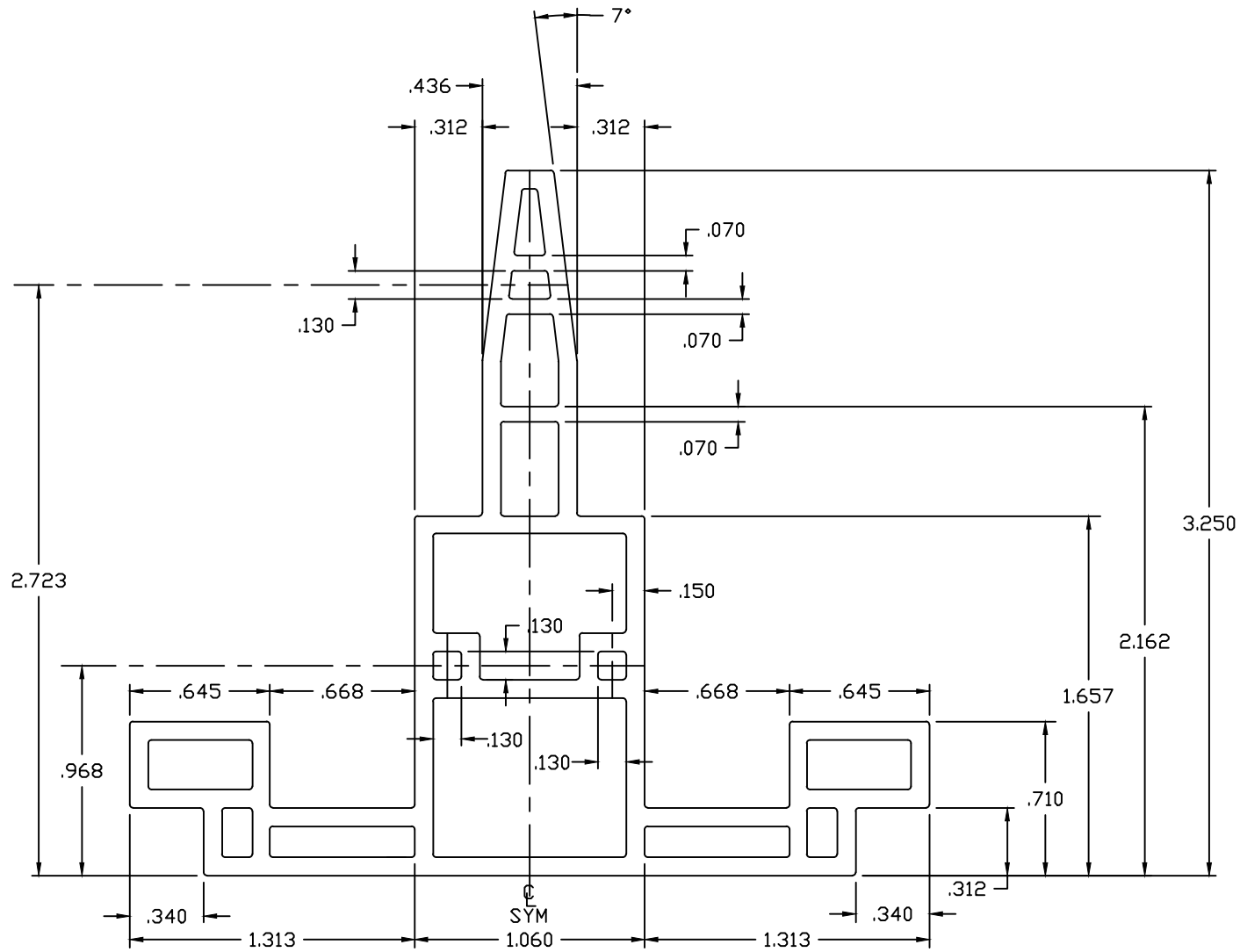



DO NOT SCALE DRAWING

NO.	REVISION	BY	DATE

LOCATION FOR IMPACT TEST  
 SPECIFICATION-LENGTHS TO 3/8"

ALLOWABLE BOW MAX. 1" PER 14'  
 ANGULARITY TO BE ± 1/2

DRAWN FOR  BY  **DDS DESIGNS**  
 "OUR NAME SAYS IT ALL"

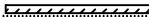
- 1) MATERIAL RIGID PVC
- 2) CAPSTOCK 
- 3) UNSPECIFIED WALLS .085
- 4) BREAK ALL CORNERS .015 R
- 5) AREA 1.535 SQ.IN.
- 6) WT/FT LBS/FT

TITLECASEMENT WINDOW CENTER POST MULLION				
DWN BY DDS	SCALE FULL	DATE 11/20/02	CHKD BY	APPD BY
COMPUTER NO				
DWG NO B-CWCPM-1261				

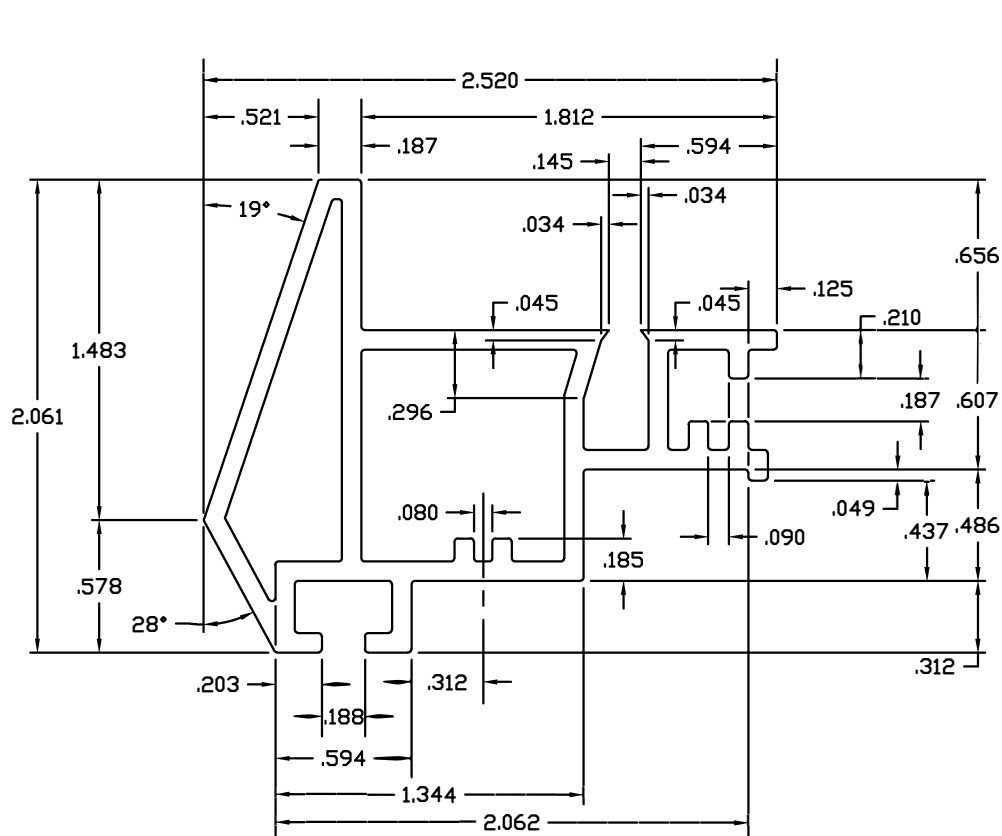

DO NOT SCALE DRAWING

		LOCATION FOR IMPACT TEST SPECIFICATION LENGTHS TO ± 3/8"	ALLOWABLE BOW MAX. 1" PER 14' ANGULARITY TO BE ± 1/2		
DRAWN FOR 		1) MATERIAL RIGID PVC 2) CAPSTOCK 3) UNSPECIFIED WALLS .080 4) BREAK ALL CORNERS .015 R 5) AREA .887 SQ. IN. 6) WT/FT LBS/FT.		TITLE CASEMENT WINDOW CASEMENT SASH	
BY 		DWN BY DDS	SCALE 2:1	DATE 11/14/02	CHKD BY 
"OUR NAME SAYS IT ALL"		APPD BY 		COMPUTER NO 	
				DWG NO 5000	

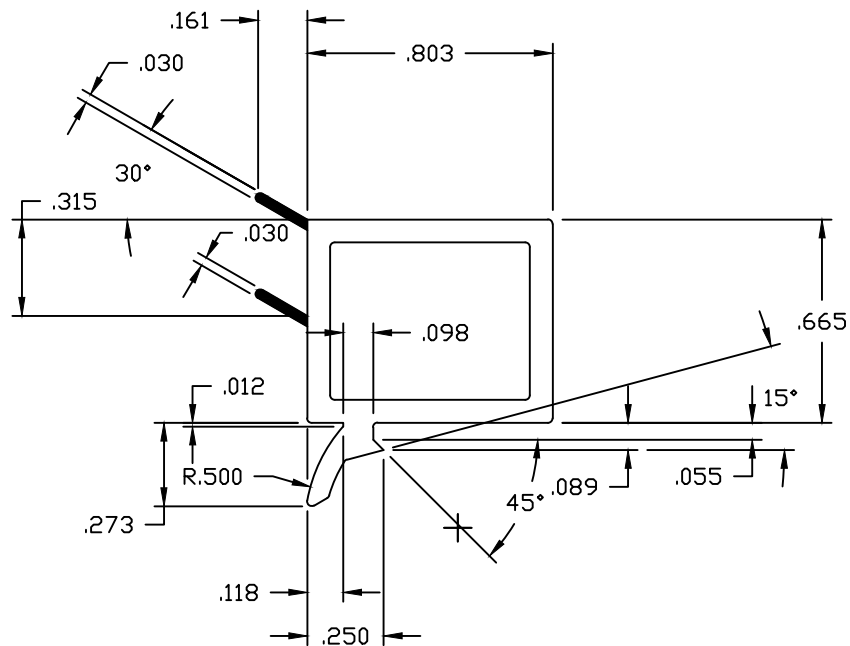
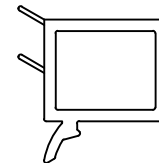

NO.	REVISION	BY	DATE		



AREA OF RIGID PVC = .229  
 AREA OF SOFT PVC = .006

WT/FT OF RIGID PVC = .144  
 WT/FT OF SOFT PVC = .004

DO NOT SCALE DRAWING

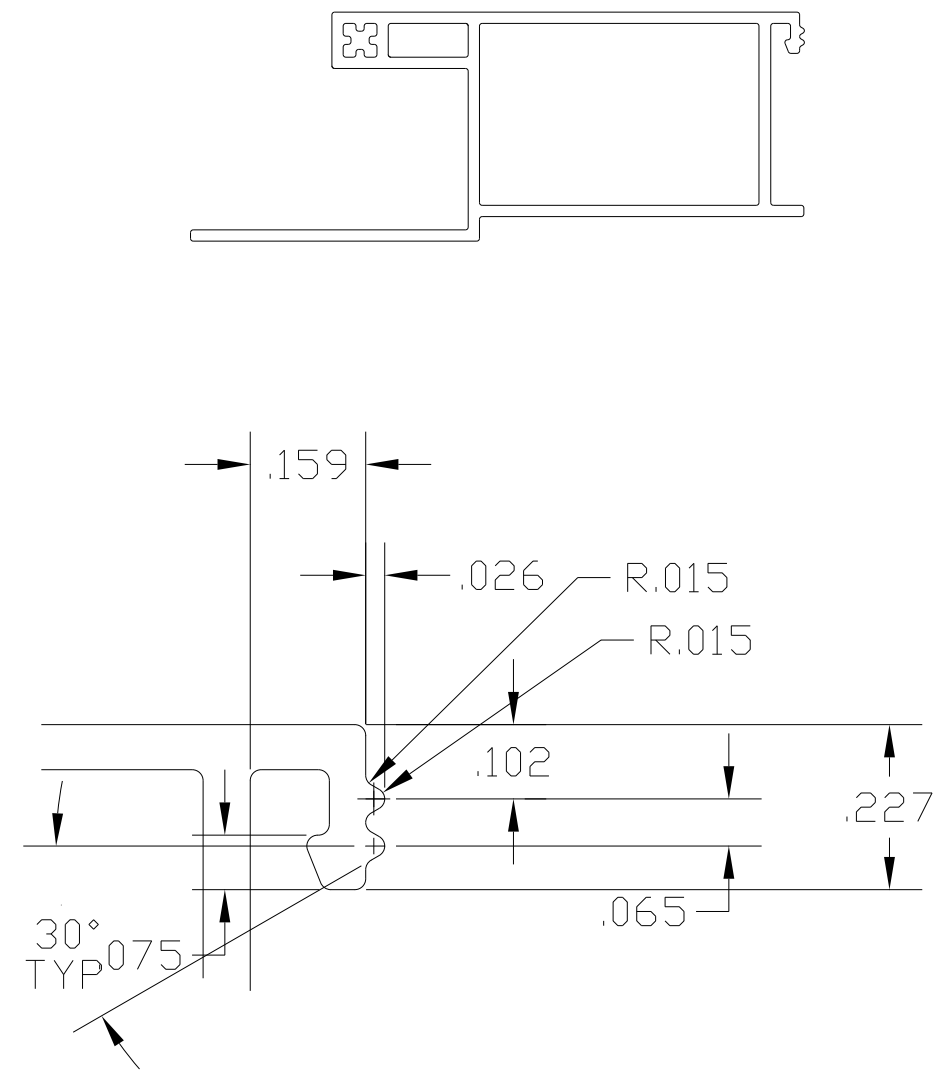
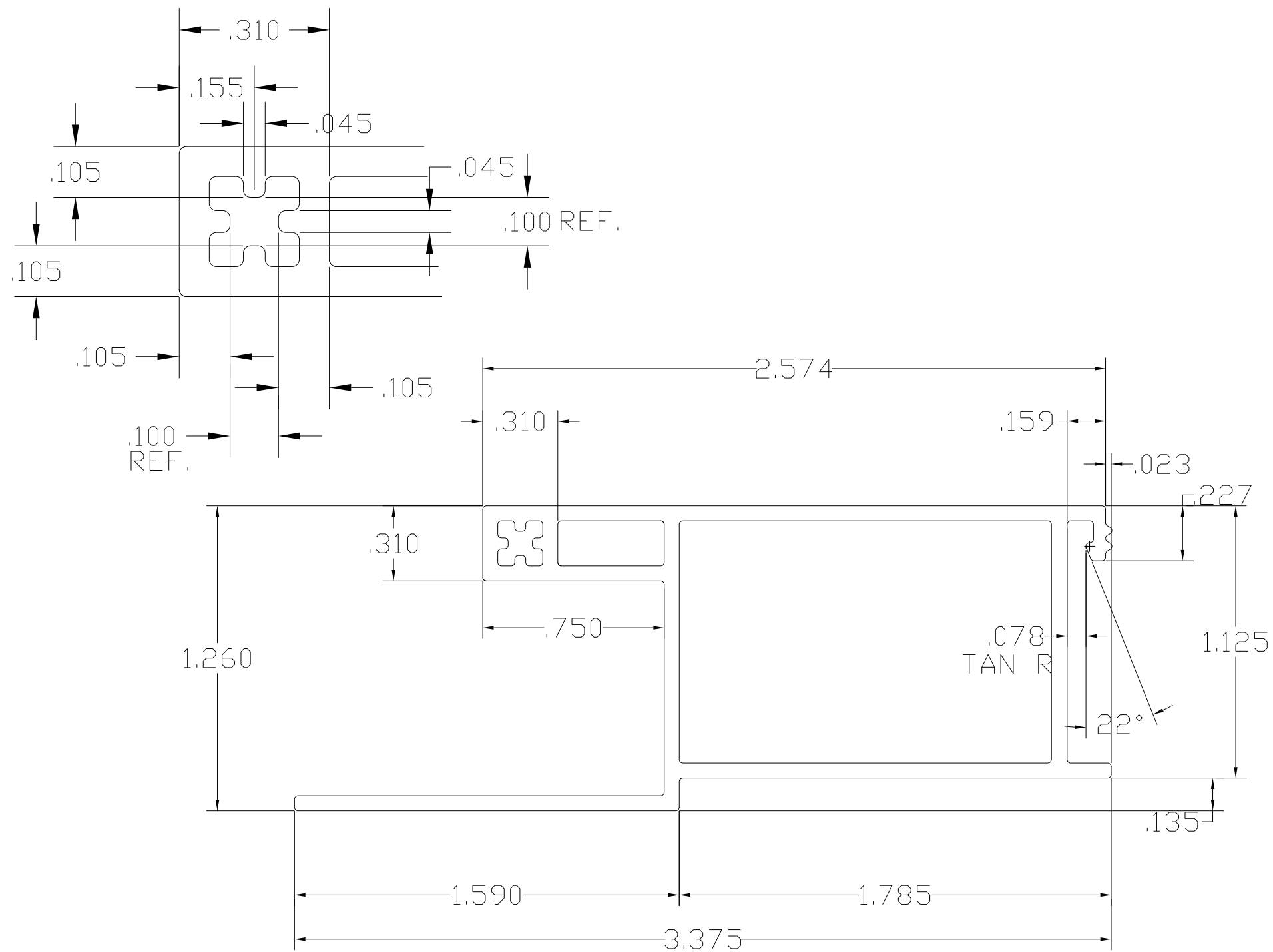

<input checked="" type="checkbox"/> LOCATION FOR IMPACT TEST SPECIFICATION—LENGTHS TO 3/8"		ALLOWABLE BOW MAX. 1" PER 14' ANGULARITY TO BE ± 1/2	
DRAWN FOR  QUALITY LINEALS	BY  DDS DESIGNS	1) MATERIAL RIGID PVC 2) CAPSTOCK 3) UNSPECIFIED WALLS .065 4) BREAK ALL CORNERS .015 R 5) AREA .235 SQ.IN. 6) WT/FT .148 LBS/FT	
		TITLE CASEMENT WINDOW CSMT GLAZING BEAD	
DWN BY DDS		SCALE FULL	DATE 11/14/02
CHKD BY		APPD BY	
COMPUTER NO			
DWG NO 5008			

NO.	REVISION	BY	DATE



DO NOT SCALE DRAWING

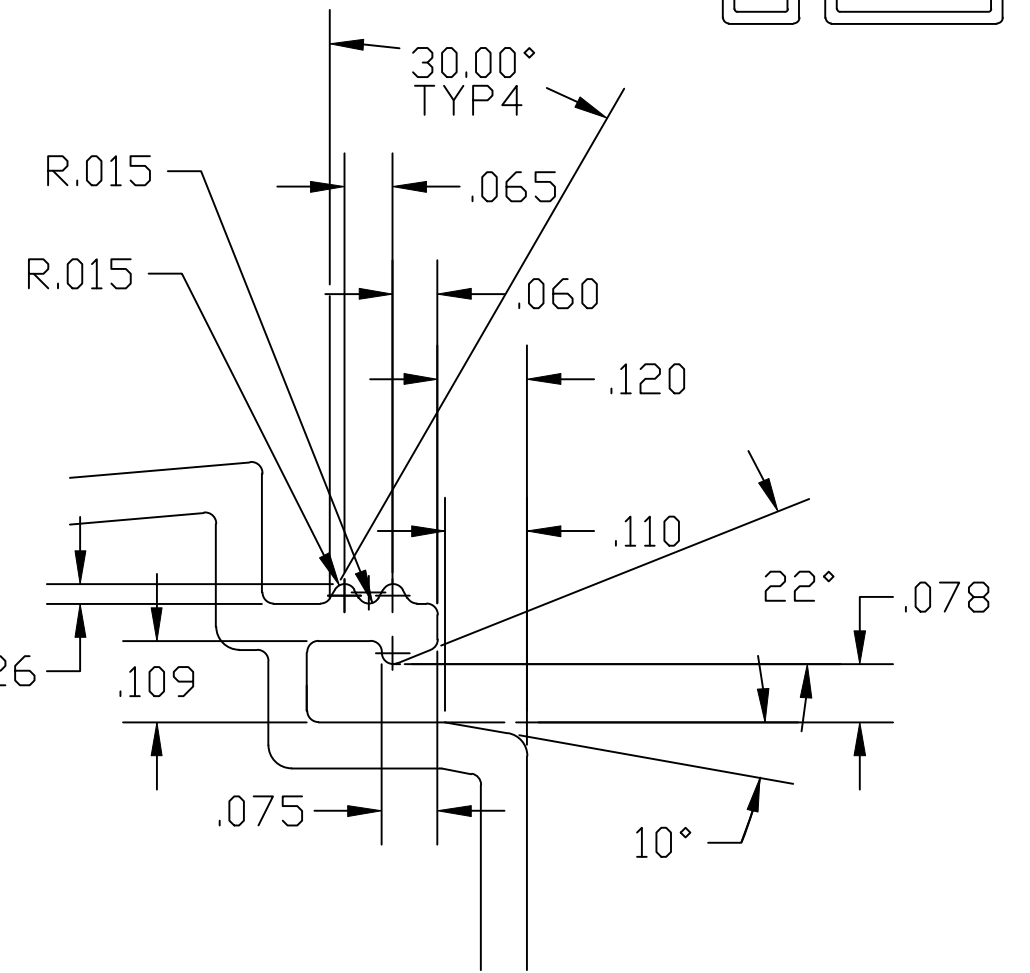
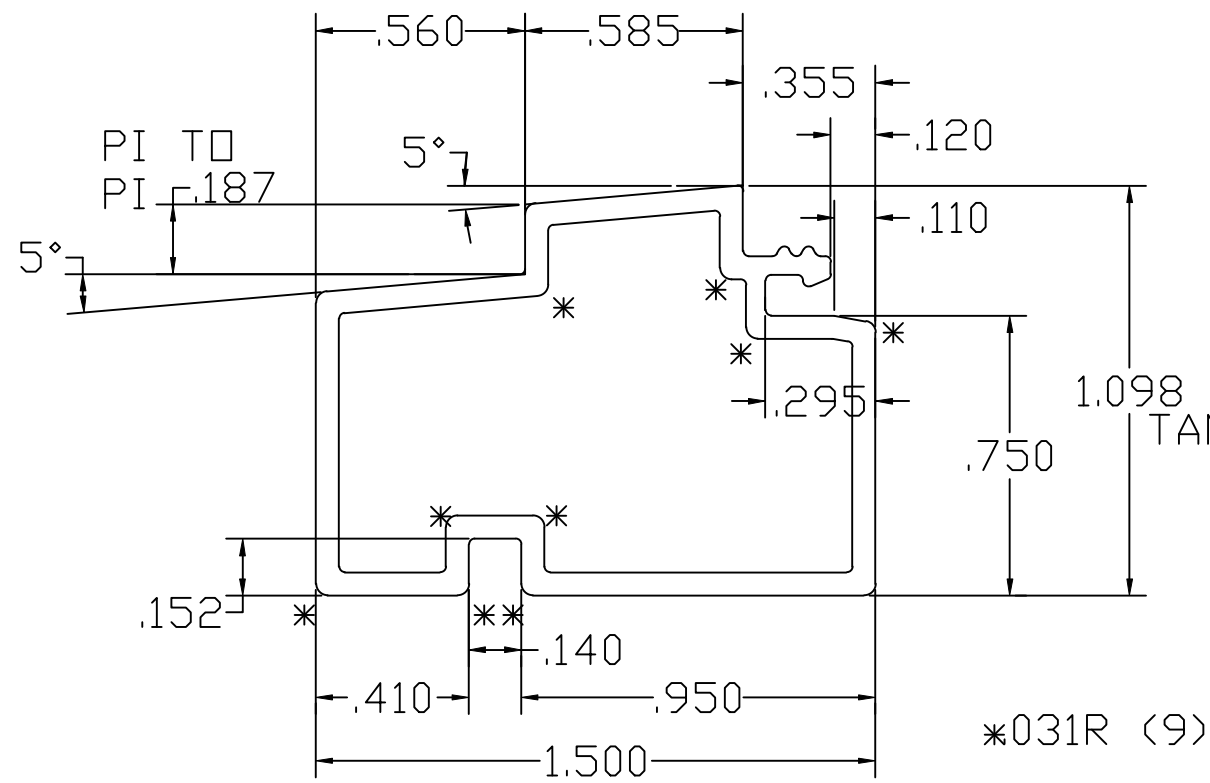
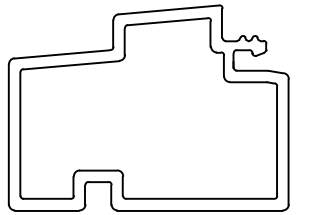

NO.	REVISION	BY	DATE

 LOCATION FOR IMPACT TEST SPECIFICATION LENGTHS TO ± 3/8"	ALLOWABLE BOW MAX. 1" PER 14' ANGULARITY TO BE ± 1/2°
DRAWN FOR 	RIGID PVC 2) CAPSTOCK 3) UNSPECIFIED WALLS .062 4) BREAK ALL CORNERS .015 R 5) AREA .589 SQ. IN. 6) WT/FT .373 LBS/FT.
"OUR NAME SAYS IT ALL"	TITLE JAMB TRIM PIECE DWN BY DDS SCALE 2:1 DATE 06-04-16 CHKD BY APPD BY COMPUTER NO DWG NO JAMB TRIM PIECE



DO NOT SCALE DRAWING

NO.	REVISION	BY	DATE

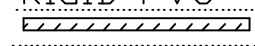
 LOCATION FOR IMPACT TEST SPECIFICATION LENGTHS TO ± 3/8"		ALLOWABLE BOW MAX. 1" PER 14' ANGULARITY TO BE ± 1/2°	
DRAWN FOR  BY  "OUR NAME SAYS IT ALL"	1) MATERIAL RIGID PVC 2) CAPSTOCK  3) UNSPECIFIED WALLS .062 4) BREAK ALL CORNERS .015 R 5) AREA .338 SQ. IN. 6) WT/FT .211 LBS/FT.		TITLE SILL TRIM PIECE
	DWN BY DDS	SCALE 2:1	DATE 06-04-16
COMPUTER NO			DWG NO SILL TRIM PIECE