

DO NOT SCALE DRAWING

NO.	REVISION	BY	DATE	

LOCATION FOR IMPACT TEST SPECIFICATION—LENGTHS TO 3/8"		ALLOWABLE BOW MAX. 1" PER 14' ANGULARITY TO BE ± 1/2°	
DRAWN FOR  QUALITY LINEALS BY DDS DESIGNS "OUR NAME SAYS IT ALL"	1) MATERIAL RIGID PVC 2) CAPSTOCK ..... 3) UNSPECIFIED WALLS 4) BREAK ALL CORNERS 015R 5) AREA ..... SQ. IN. 6) WT./FT ..... LBS/FT		TITLE SERIES 900—DOUBLE HUNG w/OPT MF WELDED MAIN FRAME / WELDED SASH
	DWN BY DDS	SCALE	DATE 11/28/11
COMPUTER NO			DWG NO C-900 DH CROSS SECTIONw/OPT .MF

# SERIES DH900-WELDED MF - WELDED SASH

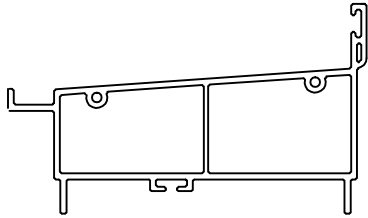

**2013  
MAIN FRAME-SILL  
WELDED**

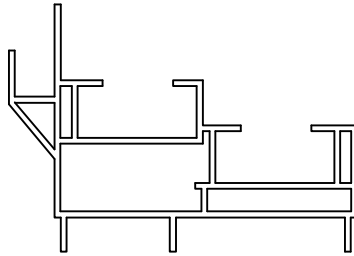

**3012  
MAIN FRAME-JAMB STANDARD  
WELDED**

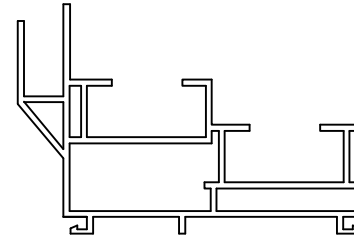

**3212  
MAIN FRAME-JAMB OPTIONAL  
WELDED**

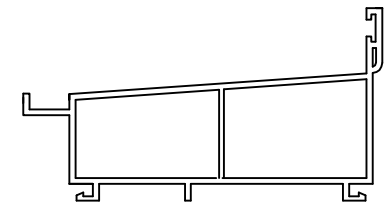

**3213  
MAIN FRAME-SILL OPTIONAL  
WELDED**

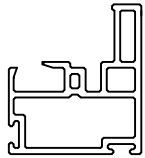

**3000  
PLAIN SASH  
WELDED**

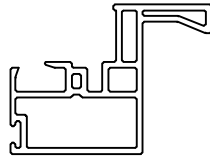

**3002  
HANDLE SASH  
WELDED**

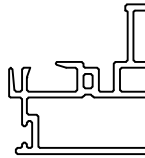

**3003  
INTERLOCK FEMALE  
WELDED**

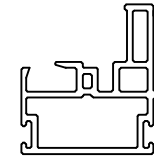

**3004  
INTERLOCK MALE  
WELDED**



**3008  
GLAZING BEAD  
WELDED**

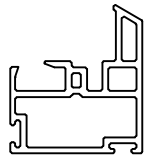

**3000B  
PLAIN SASH-BEVELED  
WELDED**

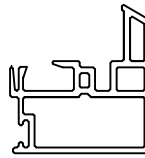

**3003B  
INTERLOCK FEMALE-BEVELED  
WELDED**

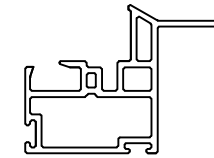

**3001  
HANDLE SASH-BEVELED  
WELDED**

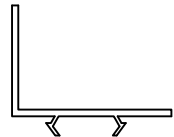

**3005  
HEAD ADAPTOR**

DRAWN FOR  "OUR NAME SAYS IT ALL"	TITLE <b>SERIES DH900 WELDED MAIN FRAME-WELDED SASH</b>				
	OWN BY DDS	SCALE	DATE 09-2-11	CHKO BY	APPD BY
	COMPUTER NO				
	DWG NO <b>C- DH 900 PROFILE CHART</b>				

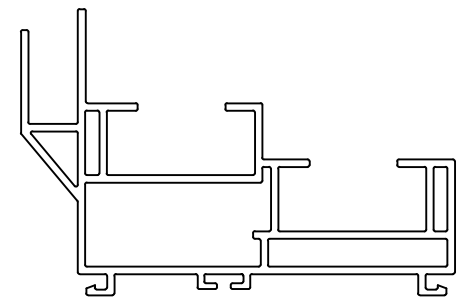
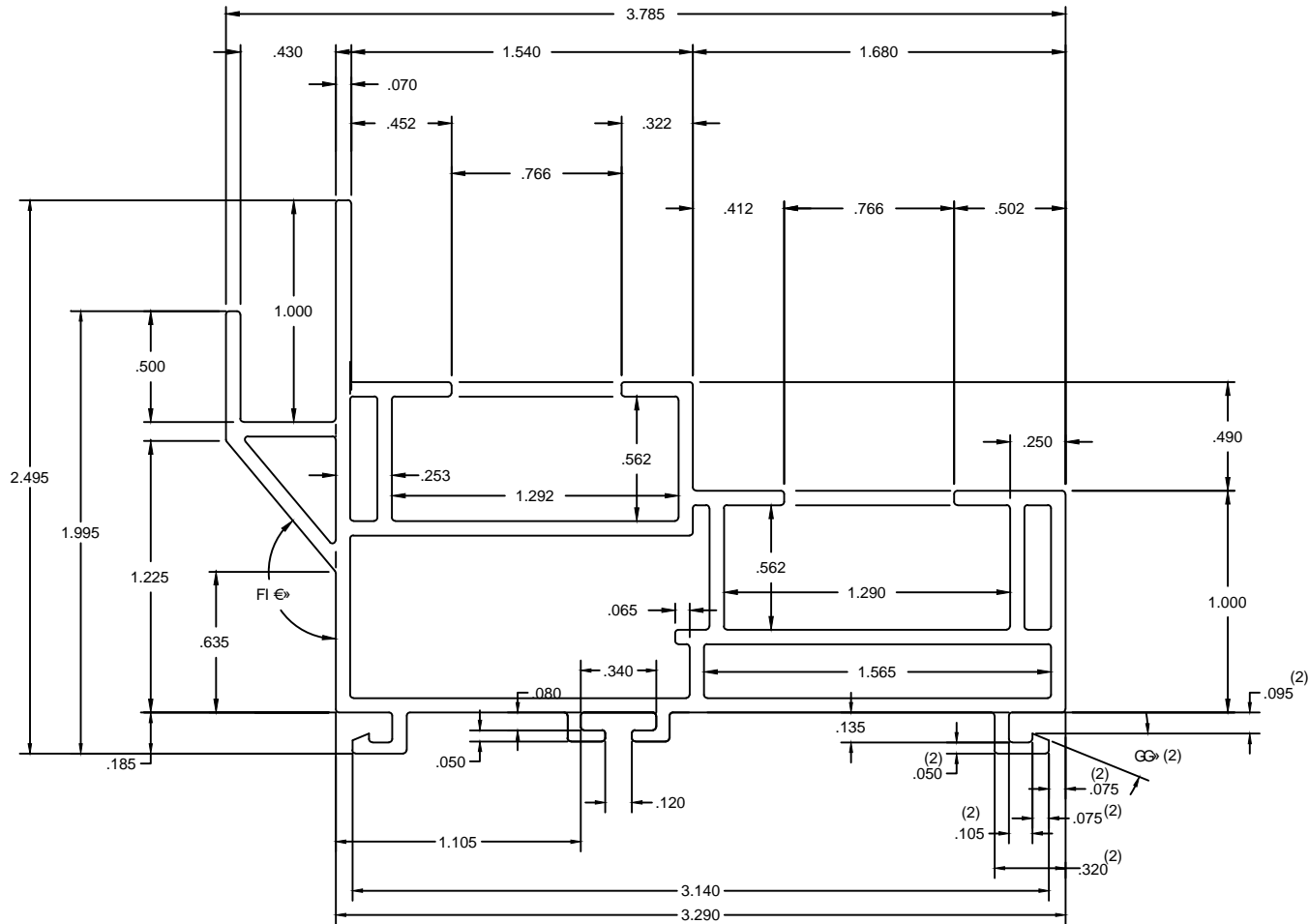

FULL SCALE

DO NOT SCALE DRAWING

LOCATION FOR IMPACT TEST SPECIFICATION-LENGTHS TO 3/8"		ALLOWABLE BOW MAX. 1" PER 14' ANGULARITY TO BE ± 1/2°		TOLERANCES- .XX ± .010 .XXX ± .005				
DRAWN FOR BY DDS DESIGNS "OUR NAME SAYS IT ALL"	1) MATERIAL RIGID PVC 2) CAPSTOCK 3) UNSPECIFIED WALLS .065 4) BREAK ALL CORNERS .015 R 5) AREA 1.109 SQ. IN. 6) WT/FT _____ LBS/FT.		TITLE WELDED DOUBLE HUNG JAMB NO FIN NO J					
	NO. A	REVISION REVISED TO "T" SLOT	BY DDS	DATE 11/28/11	DWN BY DDS	SCALE 2:1	DATE 11-05-10	CHKD BY
				COMPUTER NO				
				DWG NO B-WDMFN-3212				

NO.	REVISION	BY	DATE
A	REVISED TO "T" SLOT	DDS	11/28/11



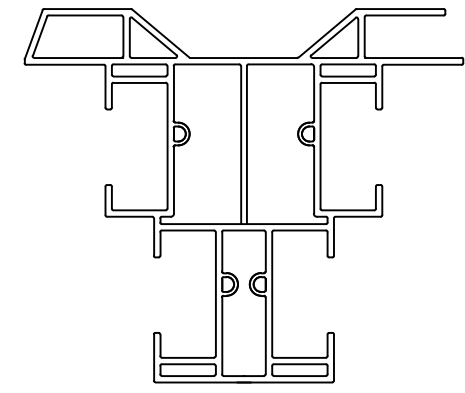
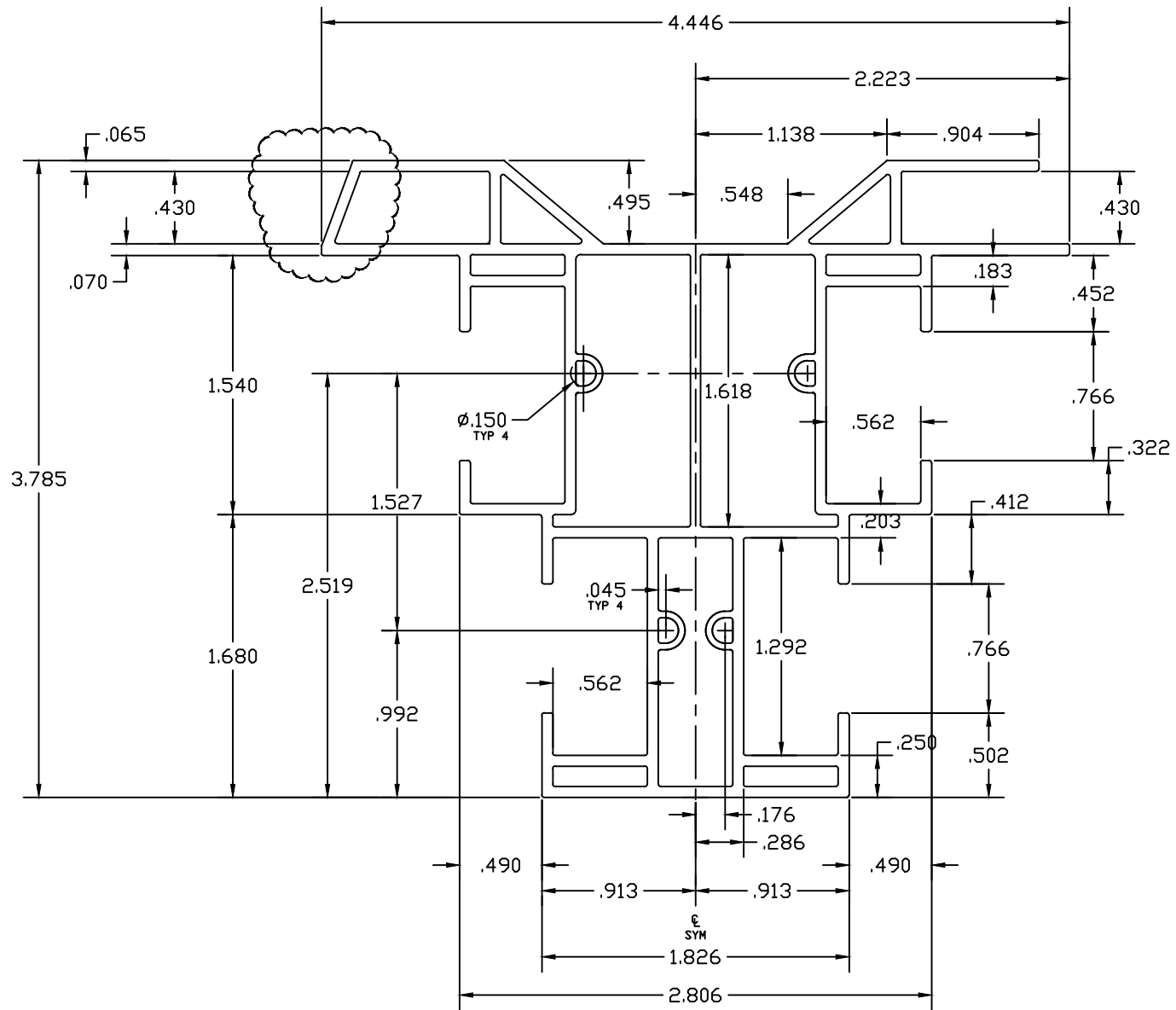



DO NOT SCALE DRAWING

NO.	REVISION	BY	DATE
1	ADDED WALL, REVISED WT/FT	DDS	12 10 19

 LOCATION FOR IMPACT TEST  
 SPECIFICATION—LENGTHS TO 3/8"

ALLOWABLE BOW MAX. 1" PER 14'  
 ANGULARITY TO BE ± 1/2°

DRAWN FOR  
  
 QUALITY LINEALS  
 BY  
  
 DDS DESIGNS  
 "OUR NAME SAYS IT ALL"

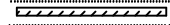
- 1) MATERIAL RIGID PVC
- 2) CAPSTOCK 
- 3) UNSPECIFIED WALLS .065
- 4) BREAK ALL CORNERS .015 R
- 5) AREA 1.783 SQ.IN.
- 6) WT/FT LBS/FT

TITLE DH 900 T-MULLION				
DWN BY DDS	SCALE 2:1	DATE 05/29/19	CHKD BY	APPD BY
COMPUTER NO				
DWG NO XXXX				

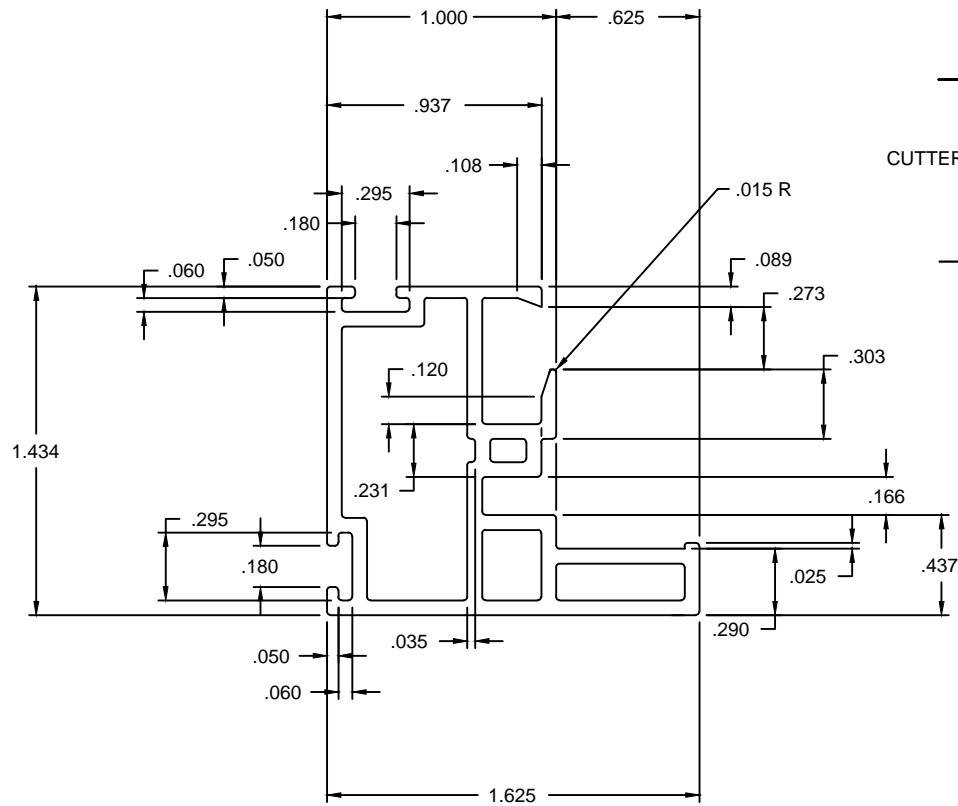

DO NOT SCALE DRAWING

☒ LOCATION FOR IMPACT TEST  
SPECIFICATION—LENGTHS TO 3/8"

ALLOWABLE BOW MAX. 1" PER 14'  
ANGULARITY TO BE ± 1/2

DRAWN FOR

BY DDS  
DESIGNS

"OUR NAME SAYS IT ALL"

- 1) MATERIAL RIGID PVC
- 2) CAPSTOCK
- 3) UNSPECIFIED WALLS .065
- 4) BREAK ALL CORNERS .015
- 5) AREA .509 SQ.IN.
- 6) WT/FT . . . . . LBS./FT.

TITLE WELDED DOUBLE HUNG REGULAR SASH				
DWN BY DDS R	SCALE 2:1	DATE 11/13/02	CHKD BY	APPD BY
COMPUTER NO				
DWG NO B-WDSH-3000				

NO.	REVISION	BY	DATE

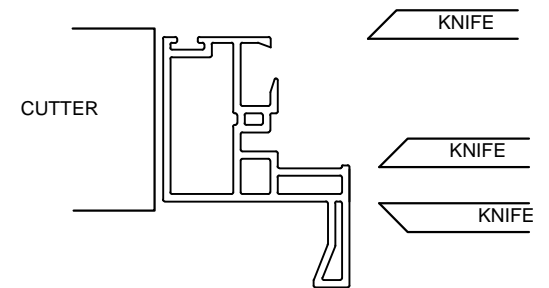
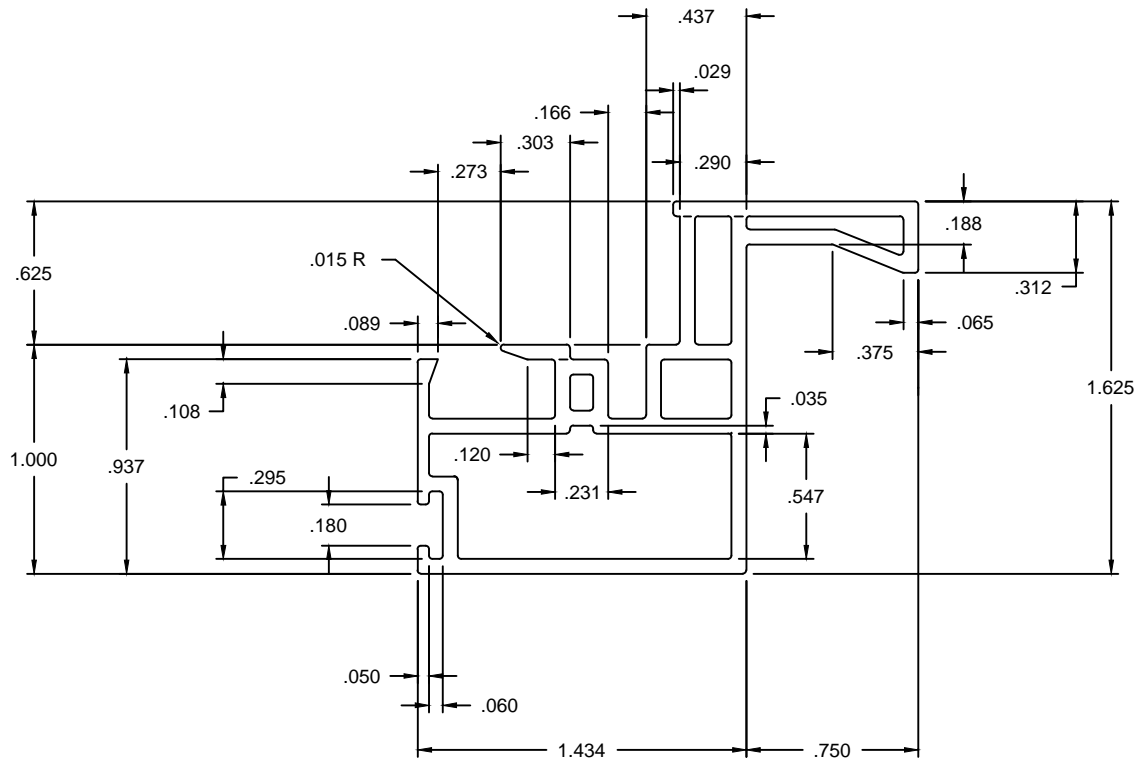

DO NOT SCALE DRAWING

☒ LOCATION FOR IMPACT TEST  
SPECIFICATION—LENGTHS TO 3/8"

ALLOWABLE BOW MAX. 1" PER 14'  
ANGULARITY TO BE ± 1/2

DRAWN FOR

QUALITY LINEALS

BY DDS  
DESIGNS

"OUR NAME SAYS IT ALL"

- 1) MATERIAL RIGID PVC
- 2) CAPSTOCK
- 3) UNSPECIFIED WALLS .065
- 4) BREAK ALL CORNERS .015 R
- 5) AREA .607 SQ.IN.
- 6) WT/FT ..... LS./FT.

TITLE WELDED DOUBLE HUNG  
HANDLE SASH

DWN BY DDS	SCALE 2:1	DATE 11/13/02	CHKD BY	APPD BY
---------------	--------------	------------------	---------	---------

COMPUTER NO

DWG NO B-WDHS-3002

NO.	REVISION	BY	DATE

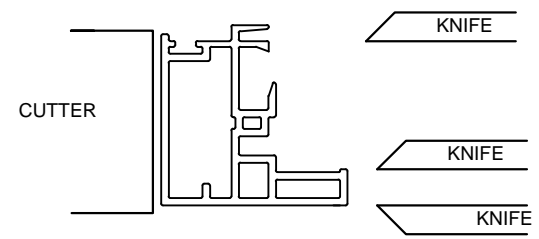
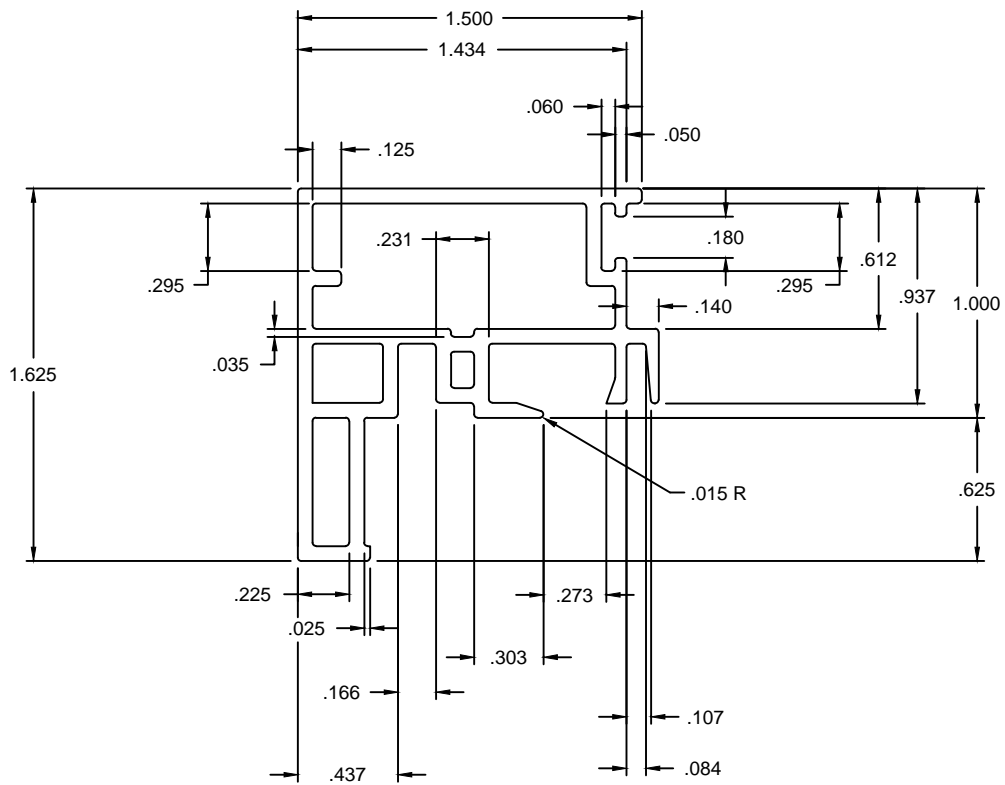

A	ADDED .125 LEG	DDS	11/28/11
NO.	REVISION	BY	DATE

	<input checked="" type="checkbox"/> LOCATION FOR IMPACT TEST SPECIFICATION—LENGTHS TO 3/8"	ALLOWABLE BOW MAX. 1" PER 14' ANGULARITY TO BE ± 1/2	DO NOT SCALE DRAWING			
	DRAWN FOR 	1) MATERIAL RIGID PVC 2) CAPSTOCK 3) UNSPECIFIED WALLS .065" 4) BREAK ALL CORNERS .015" 5) AREA .529 SQ.IN. 6) WT/FT LBS./FT.	TITLE WELDED DOUBLE HUNG FEMALE			
	DWN BY DDSR	SCALE 2:1	DATE 11/13/02	CHKD BY	APPD BY	
	COMPUTER NO					
	DWG NO B-WDIF-3003					

"OUR NAME SAYS IT ALL"



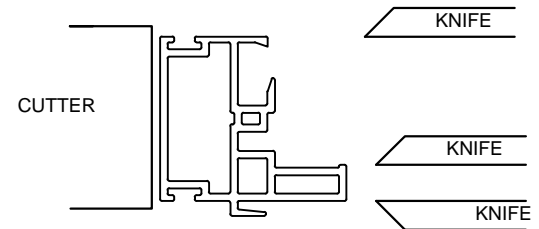
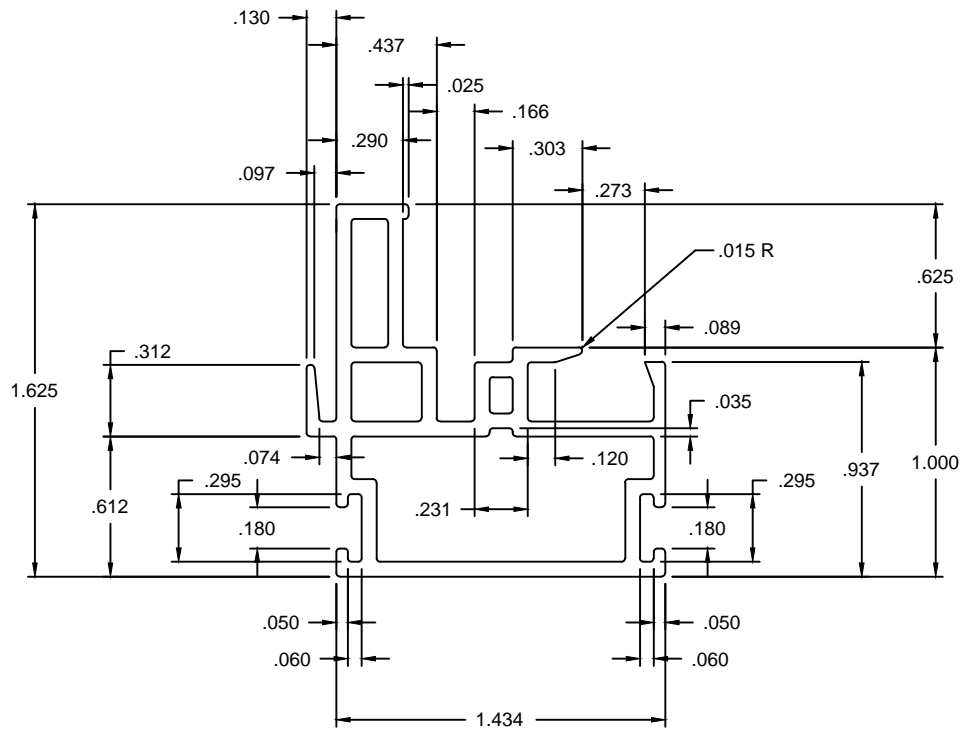

NO.	REVISION	BY	DATE

	∇ LOCATION FOR IMPACT TEST SPECIFICATION—LENGTHS TO 3/8"	ALLOWABLE BOW MAX. 1" PER 14' ANGULARITY TO BE ± 1/2	DO NOT SCALE DRAWING			
DRAWN FOR BY DDS DESIGNS "OUR NAME SAYS IT ALL"	1) MATERIAL RIGID PVC 2) CAPSTOCK 3) UNSPECIFIED WALLS .065" 4) BREAK ALL CORNERS .015" 5) AREA .528 SQ.IN. 6) WT/FT LBS./FT.	TITLE WELDED DOUBLE HUNG MALE				
	DWN BY DDS R	SCALE 2:1	DATE 11/14/02	CHKD BY	APPD BY	
	COMPUTER NO					
	DWG NO B-WDIM-3004					

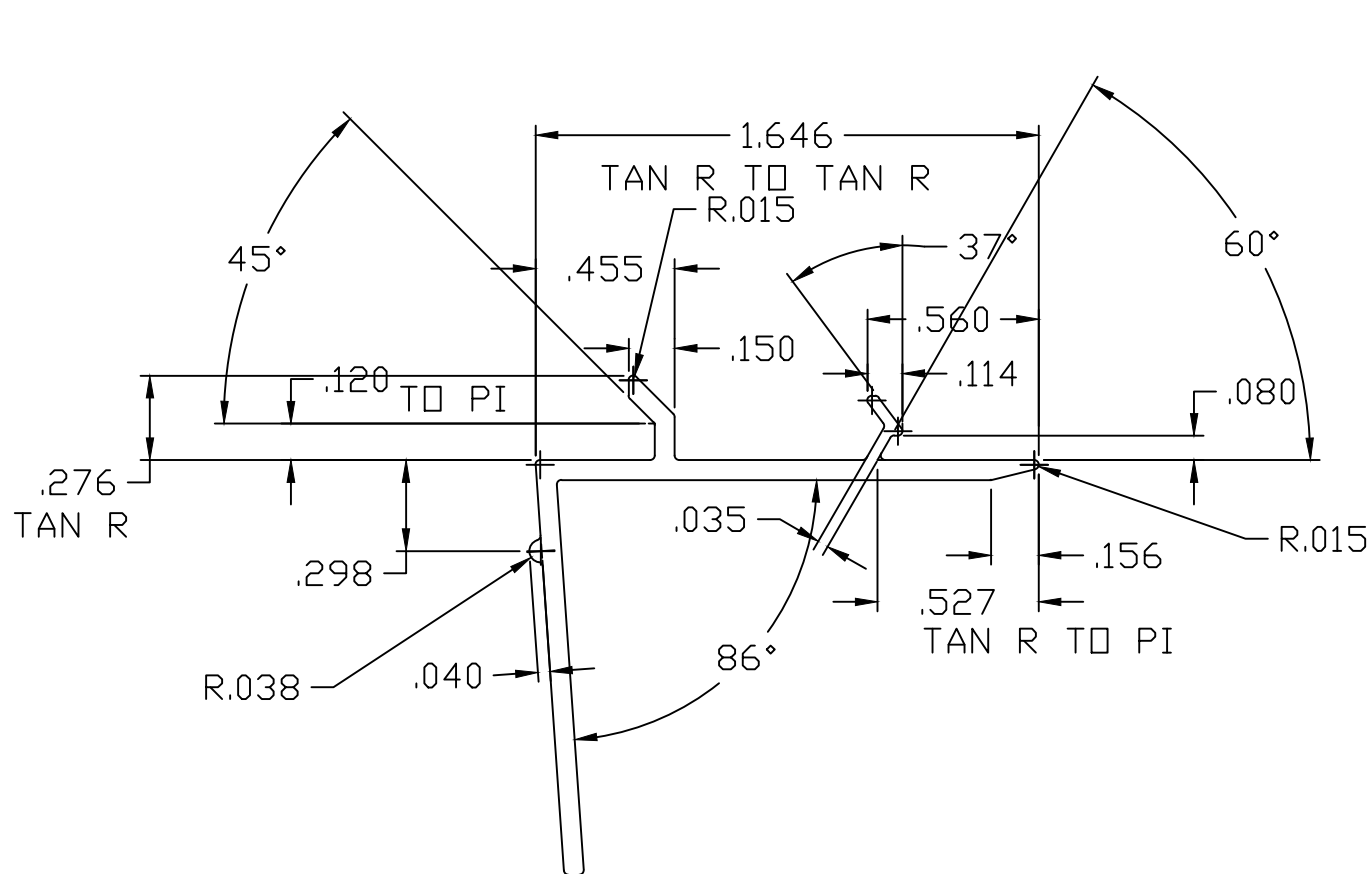

DO NOT SCALE DRAWING

☑ LOCATION FOR IMPACT TEST  
SPECIFICATION—LENGTHS TO 3/8"

ALLOWABLE BOW MAX. 1" PER 14'  
ANGULARITY TO BE ± 1/2

DRAWN FOR



QUALITY LINEALS

BY DDS  
DESIGNS

"OUR NAME SAYS IT ALL"

- 1) MATERIAL RIGID PVC
- 2) CAPSTOCK ~~XXXXXXXXXX~~
- 3) UNSPECIFIED WALLS .065
- 4) BREAK ALL CORNERS .015 R
- 5) AREA .219 SQ.IN.
- 6) WT/FT LBS/FT

TITLE WELDED DOUBLE HUNG  
HEAD ADAPTER

DWN BY DDS	SCALE FULL	DATE 02 01 23	CHKD BY	APPD BY
---------------	---------------	------------------	---------	---------

COMPUTER NO

DWG NO 3005-REVISED

NO.	REVISION	BY	DATE

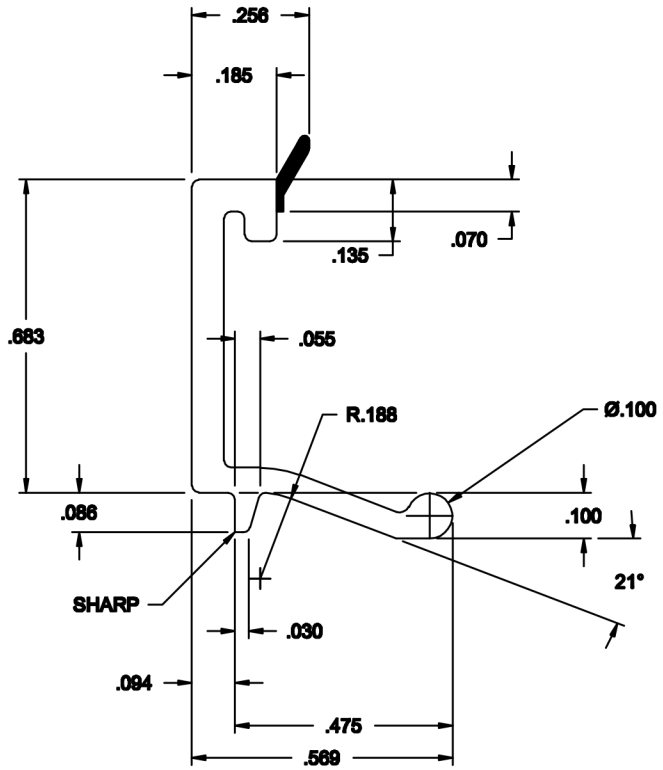
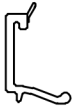

AREA OF RIGID PVC = .096  
 AREA OF SOFT PVC = .004  
 WT/FT OF RIGID PVC = .060  
 WT/FT OF SOFT PVC = .003

DO NOT SCALE DRAWING

<b>NO.</b>	<b>REVISION</b>	<b>BY</b>	<b>DATE</b>

<p>BY DDS DESIGNS</p> <p>"OUR NAME SAYS IT ALL"</p>	LOCATION FOR IMPACT TEST SPECIFICATION-LENGTHS TO 3/8"	ALLOWABLE BOW MAX. 1" PER 14' ANGULARITY TO BE ± 1/2°	TOLERANCES- XX ± .010 XXX ± .005			
	1) MATERIAL RIGID PVC 2) CAPSTOCK 3) UNSPECIFIED WALLS .070 4) BREAK ALL CORNERS .015 R 5) AREA .100 SQ.IN. 6) WT/FT LBS/FT	TITLE WELDED DOUBLE HUNG GLAZING BEAD				
	DRAWN FOR 	DWN BY DDS	SCALE 4:1	DATE 11/20/02	CHKD BY	APPD BY
		COMPUTER NO		DWG NO B-WDGB-3008		