



DO NOT SCALE DRAWING

NO.	REVISION	BY	DATE

LOCATION FOR IMPACT TEST SPECIFICATION—LENGTHS TO 3/8"

DRAWN FOR  QUALITY LINEALS BY  DDS DESIGNS "OUR NAME SAYS IT ALL"	1) MATERIAL RIGID PVC 2) CAPSTOCK 3) UNSPECIFIED WALLS 4) BREAK ALL CORNERS .015R 5) AREA SQ. IN. 6) WT/FT LBS/FT	TITLE PW630 V & H CROSS CUT			
	DWN BY DDS	SCALE	DATE 08/11/16	CHKD BY	APPD BY
		COMPUTER NO			
		DWG NO C- PW630 CROSS CUT			

# PICTURE WINDOW 2 5/8" MF

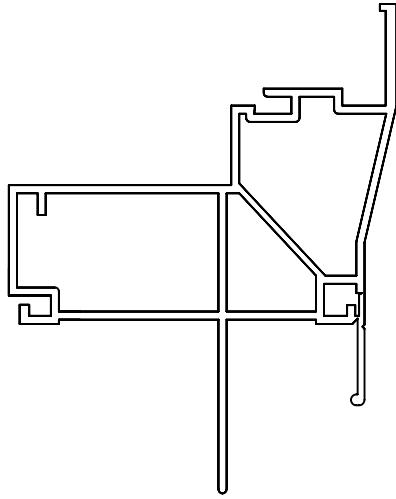

1511  
PICTURE WINDOW MAIN FRAME w/ FIN & J  
WELDED

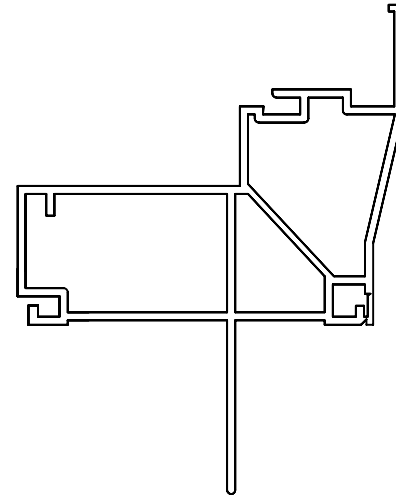

1611  
PICTURE WINDOW MAIN FRAME w/ FIN  
WELDED

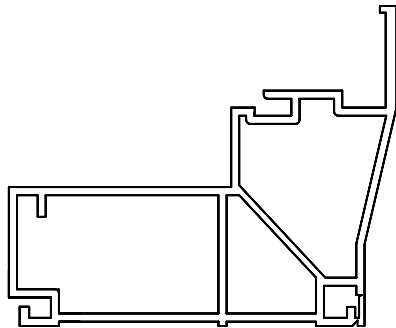

1011  
PICTURE WINDOW MAIN FRAME NO FIN  
WELDED



1008  
NEW CONSTRUCTION PW  
GLAZING BEAD

DRAWN FOR  QUALITY LINEALS BY DDS DESIGNS "OUR NAME SAYS IT ALL"	TITLE PICTURE WINDOW 2 5/8" MF WELDED				
	DWN BY DDS	SCALE	DATE 09-2-11	CHKD BY	APPD BY
	COMPUTER NO				
DWG NO		C- PROFILE CHART 11			

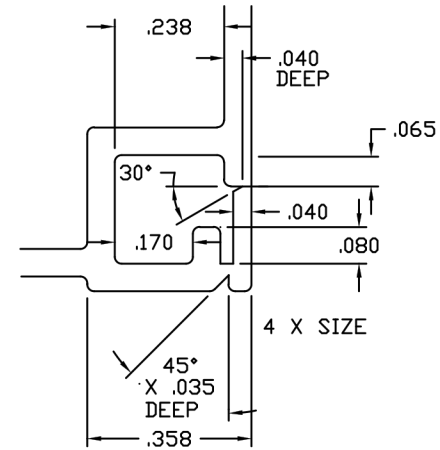
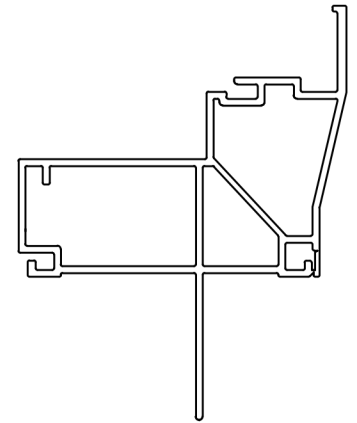
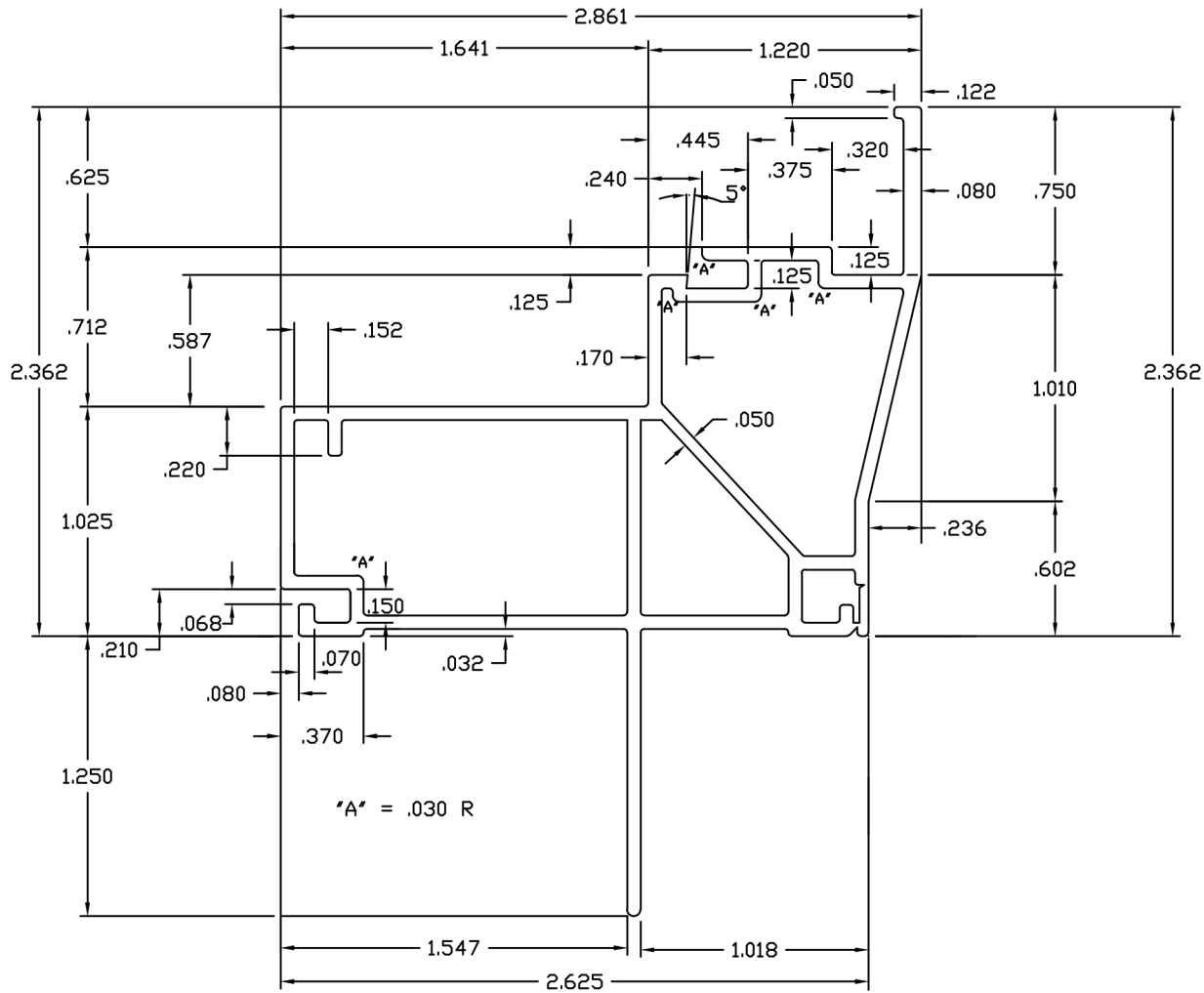

DO NOT SCALE DRAWING

NO.	REVISION	BY	DATE

☒ LOCATION FOR IMPACT TEST SPECIFICATION—LENGTHS TO 3/8"

ALLOWABLE BOW MAX. 1" PER 14' ANGULARITY TO BE ± 1/2°

DRAWN FOR

BY DDS DESIGNS

"OUR NAME SAYS IT ALL"

- 1) MATERIAL RIGID PVC
- 2) CAPSTOCK
- 3) UNSPECIFIED WALLS .060
- 4) BREAK ALL CORNERS .015 R
- 5) AREA 1.021 SQ.IN.
- 6) WT/FT LBS/FT

TITLE BUILDERS WINDOW HEAD WITH FIN NO J				
DWN BY	SCALE	DATE	CHKD BY	APPD BY
DDS	2:1	11/19/02		
COMPUTER NO				
DWG NO B-SHHF-1611				

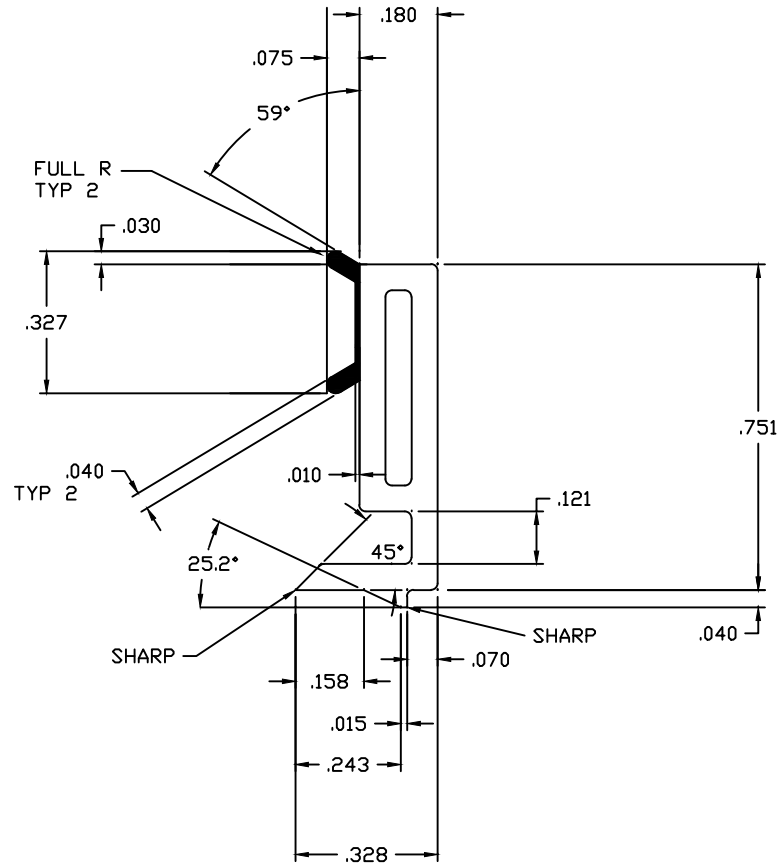

AREA OF RIGID PVC=.105  
 WT/FT OF RIGID PVC=.066

AREA OF FLEX PVC=.008  
 WT/FT OF FLEX PVC=.006

TOTAL AREA=.113  
 TOTAL WT/FT=.071

DO NOT SCALE DRAWING

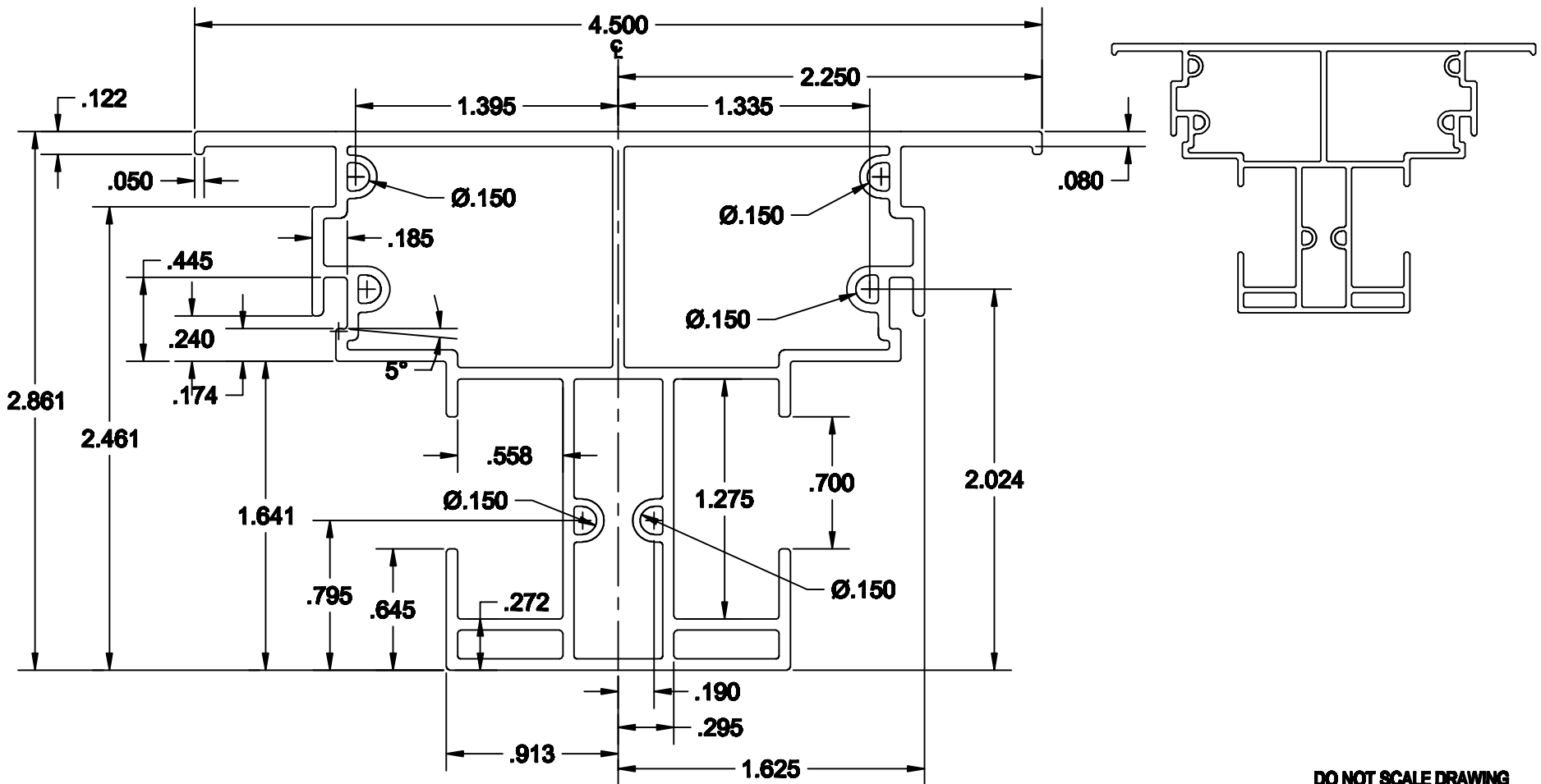

NO.	REVISION	BY	DATE

<input checked="" type="checkbox"/> LOCATION FOR IMPACT TEST SPECIFICATION—LENGTHS TO 3/8"			
DRAWN FOR  BY DDS DESIGNS "OUR NAME SAYS IT ALL"	1) MATERIAL RIGID PVC 2) CAPSTOCK 3) UNSPECIFIED WALLS .060 4) BREAK ALL CORNERS .015R 5) AREA .113 SQ.IN. 6) WT/FT LBS/FT		TITLE SH660 GLAZING BEAD
	DWN BY DDS	SCALE 4:1	DATE 1-8-99



DO NOT SCALE DRAWING

<b>NO.</b>	<b>REVISION</b>	<b>BY</b>	<b>DATE</b>

<input checked="" type="checkbox"/> LOCATION FOR IMPACT TEST SPECIFICATION-LENGTHS TO 3/8"	ALLOWABLE BOW MAX. 1" PER 14' ANGULARITY TO BE ± 1/2°	<b>TOLERANCES-</b> XX ± .010 XXX ± .005										
DRAWN FOR  BY  "OUR NAME SAYS IT ALL"	1) MATERIAL RIGID PVC 2) CAPSTOCK 3) UNSPECIFIED WALLS .080 4) BREAK ALL CORNERS .015 R 5) AREA 1.012 SQ. IN. 6) WT/FT LBS./FT.	<b>TITLE BUILDERS WINDOW T-MULLION</b> <table border="1"> <tr> <td>DWN BY DDS</td> <td>SCALE 2:1</td> <td>DATE 03/14/16</td> <td>CHKD BY</td> <td>APPD BY</td> </tr> <tr> <td colspan="5">COMPUTER NO</td> </tr> </table> DWG NO <b>XXXX</b> SH T MULL	DWN BY DDS	SCALE 2:1	DATE 03/14/16	CHKD BY	APPD BY	COMPUTER NO				
DWN BY DDS	SCALE 2:1	DATE 03/14/16	CHKD BY	APPD BY								
COMPUTER NO												