

DO NOT SCALE DRAWING

NO.	REVISION	BY	DATE

		BY DDS DESIGNS		1) MATERIAL RIGID PVC 2) CAPSTOCK 3) UNSPECIFIED WALLS 4) BREAK ALL CORNERS 5) AREA SQ.IN. 6) WT/FT LBS/FT		TITLE SH660 w/TALL SILL SNAP IN CROSS CUTS FIN & J	
DRAWN FOR		R .015		DWN BY DDS		SCALE	
"OUR NAME SAYS IT ALL"		COMPUTER NO		DATE 09/14/14		CHKD BY	
"OUR NAME SAYS IT ALL"		COMPUTER NO		APPD BY		DWG NO C- SH660 CROSS CUT	

SH NEW CONSTRUCTION (2 5/8") WELDED MF & SASH

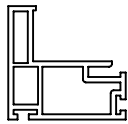

1000
PLAIN SASH
WELDED

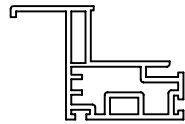

1002
HANDLE SASH
WELDED

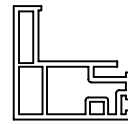

1004
FEMALE SASH
WELDED



1008
GLAZING BEAD



1009
INTERLOCK
GLAZING BEAD

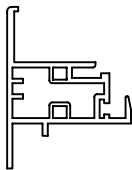

1003
FIXED MEETING RAIL

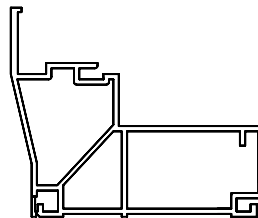

1011
NEW CONSTRUCTION SH HEAD
NO FIN WELDED

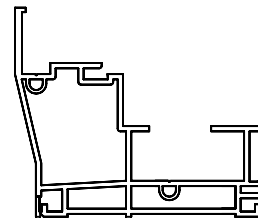

1012
NEW CONSTRUCTION SH JAMB
NO FIN WELDED

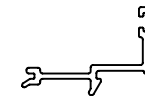

1014
NEW CONSTRUCTION
SH SILL INSERT

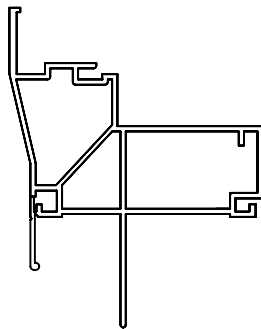

1511
NEW CONSTRUCTION SH HEAD
w/ FIN & J

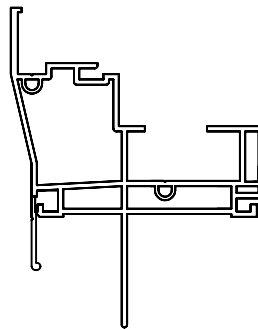

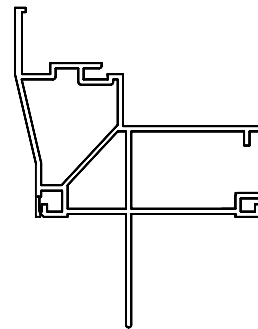

1512
NEW CONSTRUCTION SH JAMB
w/ FIN & J

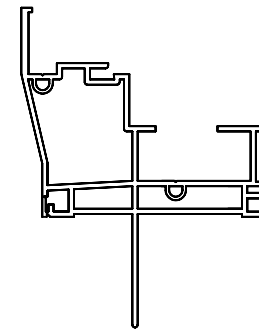

1611
NEW CONSTRUCTION SH HEAD
w/ FIN



1612
NEW CONSTRUCTION SH JAMB
w/ FIN

DRAWN FOR  BY  DDS DESIGNS "OUR NAME SAYS IT ALL"	TITLE SINGLE HUNG 2 5/8" MF NEW CONSTRUCTION WELDED				
	DWN BY DDS	SCALE	DATE 09-02-11	CHKD BY	APPD BY
	COMPUTER NO				
DWG NO C-PROFILE CHART 9					

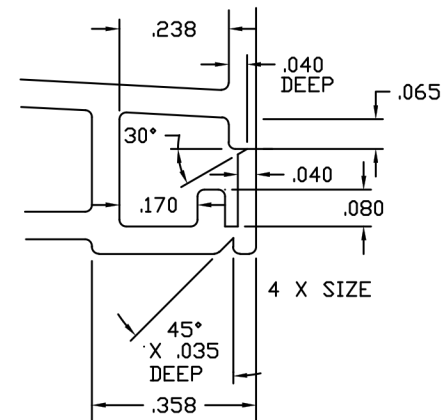
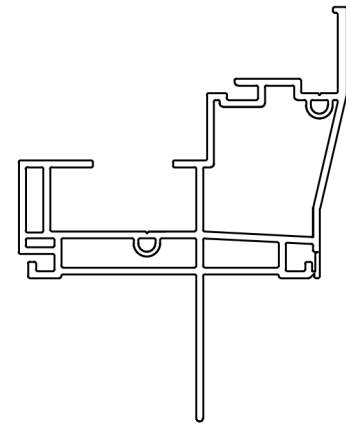
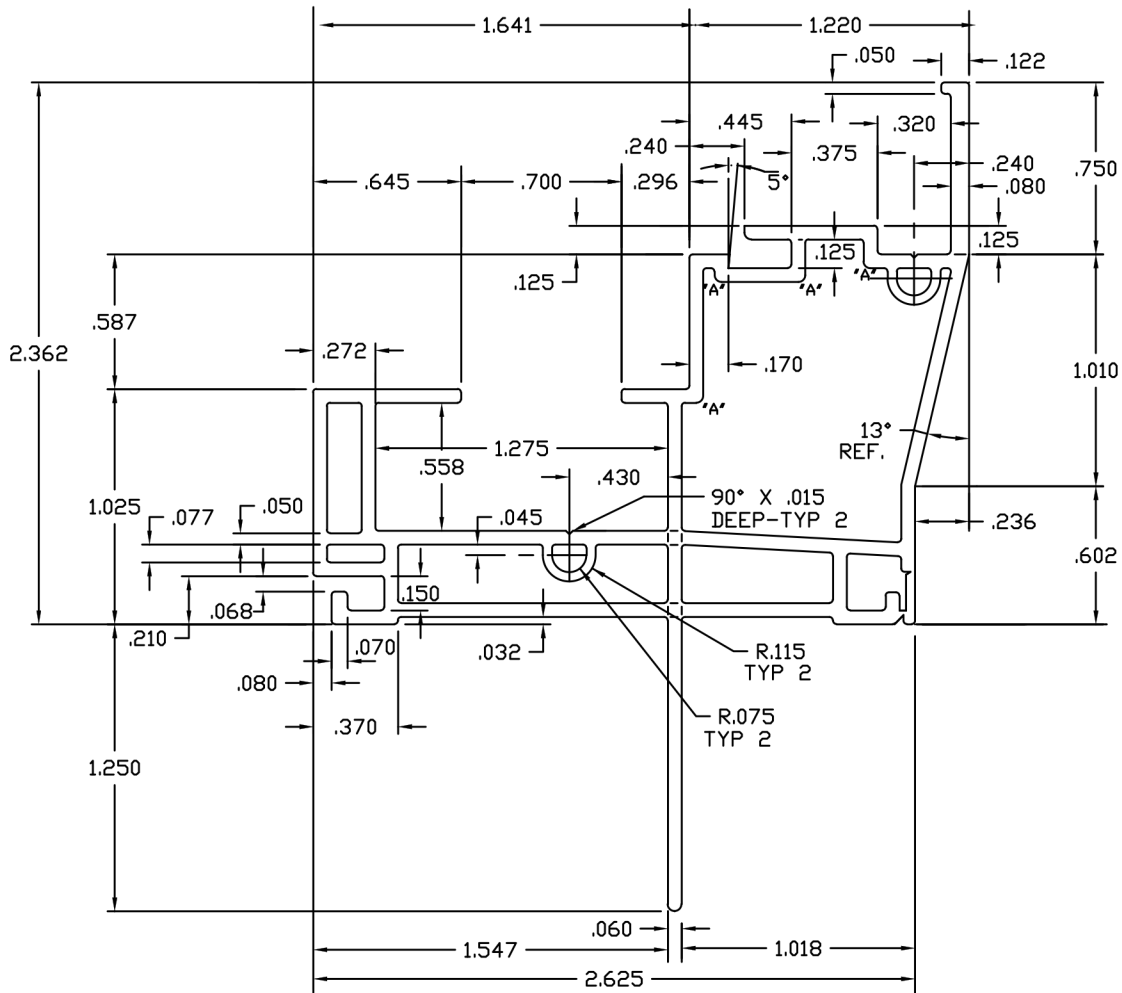



DO NOT SCALE DRAWING

NO.	REVISION	BY	DATE

 LOCATION FOR IMPACT TEST
 SPECIFICATION—LENGTHS TO 3/8"

ALLOWABLE BOW MAX. 1" PER 14'
 ANGULARITY TO BE ± 1/2"

DRAWN FOR  BY  **DDS DESIGNS**
 "OUR NAME SAYS IT ALL"

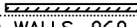
- 1) MATERIAL RIGID PVC
- 2) CAPSTOCK 
- 3) UNSPECIFIED WALLS .060
- 4) BREAK ALL CORNERS .015R
- 5) AREA 1.086 SQ.IN.
- 6) WT/FT "LBS/FT"

TITLE BUILDERS WINDOW JAMB WITH FIN NO J				
DWN BY DDS	SCALE 2:1	DATE 11/19/02	CHKD BY	APPD BY
COMPUTER NO				
DWG NO 1612				

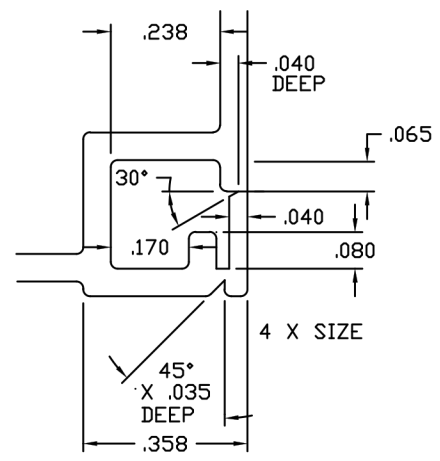
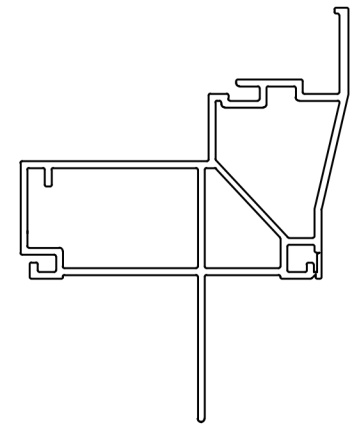
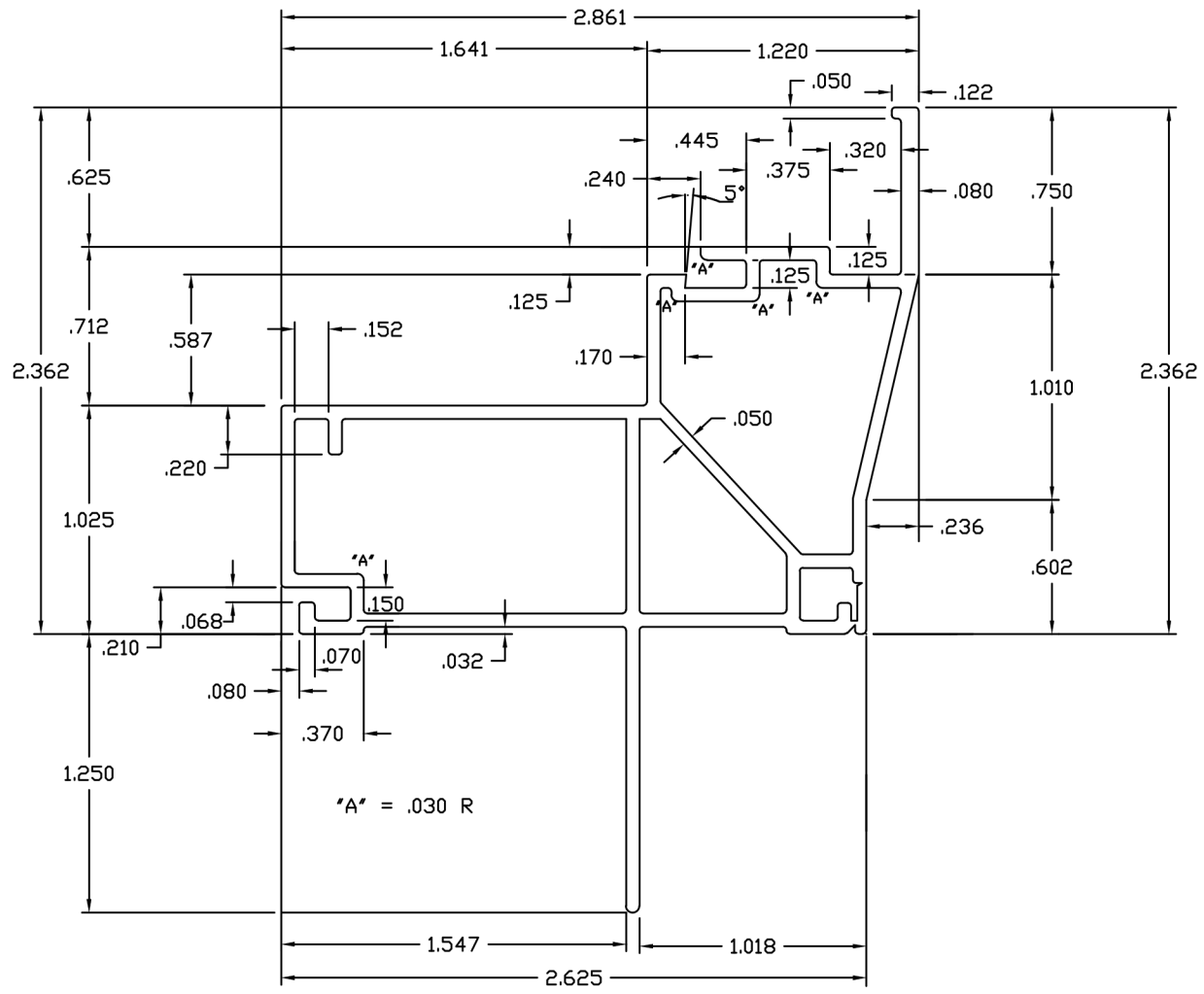

DO NOT SCALE DRAWING

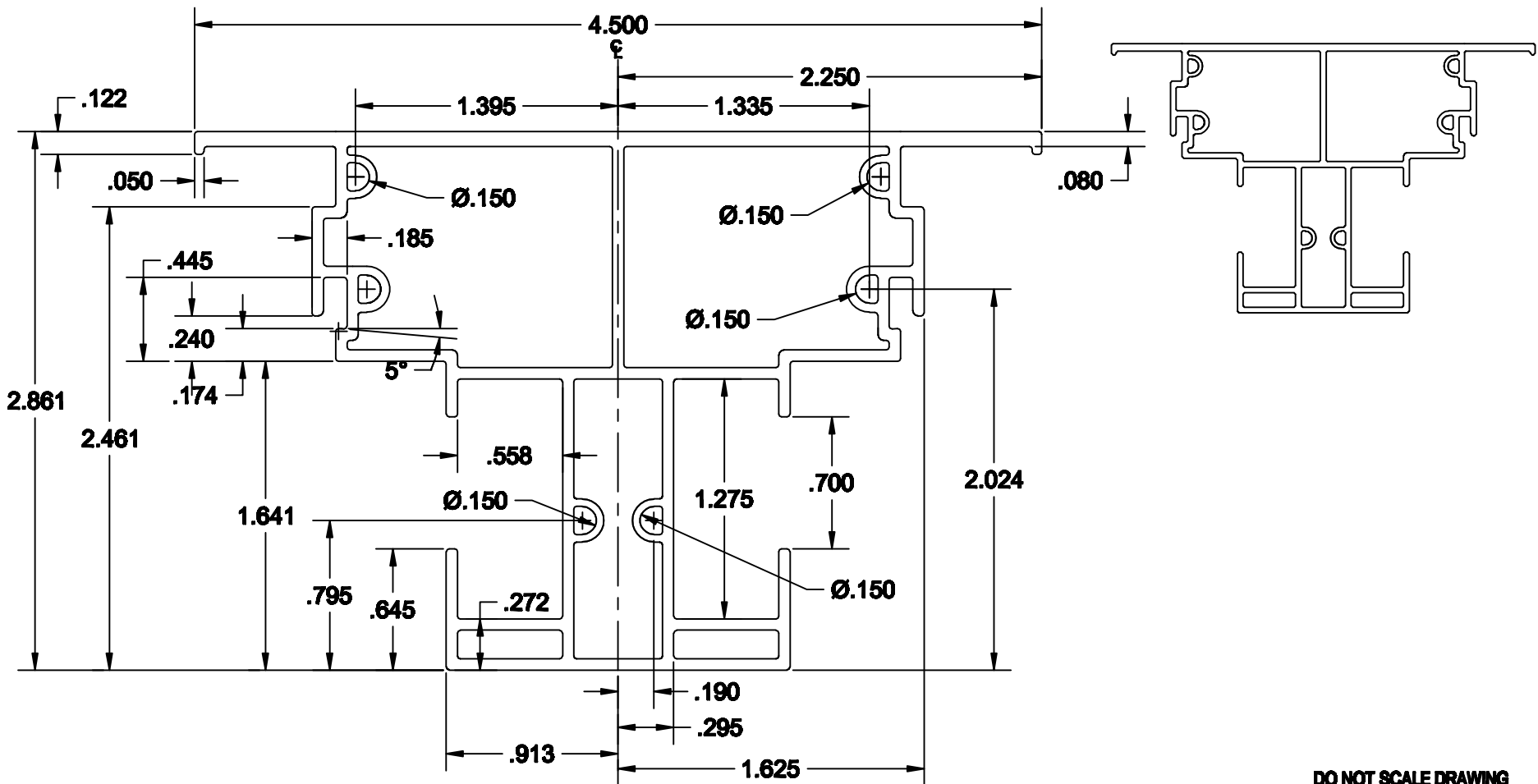

NO.	REVISION	BY	DATE

LOCATION FOR IMPACT TEST SPECIFICATION—LENGTHS TO 3/8"		ALLOWABLE BOW MAX. 1" PER 14' ANGULARITY TO BE ± 1/2°	
DRAWN FOR BY "OUR NAME SAYS IT ALL"	1) MATERIAL RIGID PVC 2) CAPSTOCK 3) UNSPECIFIED WALLS .060 4) BREAK ALL CORNERS .015 R 5) AREA 1.021 SQ.IN. 6) WT/FT LBS/FT		
	TITLE BUILDERS WINDOW HEAD WITH FIN NO J DWN BY DDS SCALE 2:1 DATE 11/19/02 CHKD BY APPD BY COMPUTER NO DWG NO B-SHHF-1611		



DO NOT SCALE DRAWING

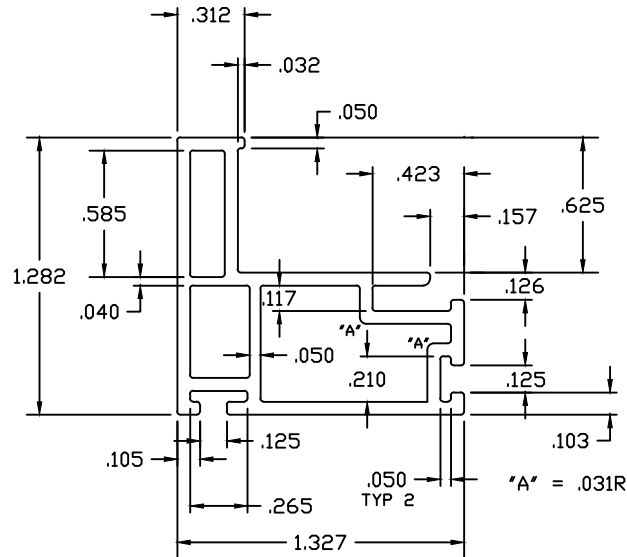
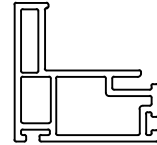

NO.	REVISION	BY	DATE

<input checked="" type="checkbox"/> LOCATION FOR IMPACT TEST SPECIFICATION-LENGTHS TO 3/8"	ALLOWABLE BOW MAX. 1" PER 14' ANGULARITY TO BE ± 1/2°	TOLERANCES- XX ± .010 XXX ± .005	
	DRAWN FOR  BY  "OUR NAME SAYS IT ALL"	1) MATERIAL RIGID PVC 2) CAPSTOCK 3) UNSPECIFIED WALLS .080 4) BREAK ALL CORNERS .015 R 5) AREA 1.012 SQ. IN. 6) WT/FT LBS./FT.	TITLE BUILDERS WINDOW T-MULLION DWN BY DDS SCALE 2:1 DATE 03/14/16 CHKD BY APPD BY COMPUTER NO
DWG NO XXXX SH T MULL			



DO NOT SCALE DRAWING

NO.	REVISION	BY	DATE

<input checked="" type="checkbox"/> LOCATION FOR IMPACT TEST SPECIFICATION—LENGTHS TO 3/8"			
DRAWN FOR  BY  DDS DESIGNS "OUR NAME SAYS IT ALL"	1) MATERIAL <u>RIGID PVC</u> 2) CAPSTOCK <u>.....</u> 3) UNSPECIFIED WALLS <u>.065</u> 4) BREAK ALL CORNERS <u>.015</u> 5) AREA <u>.394 SQ.IN.</u> 6) WT/FT <u>.....</u> LBS/FT	TITLE SH660 REGULAR SASH	
	DWN BY DDS ^R	SCALE 2:1	DATE 1-6-99

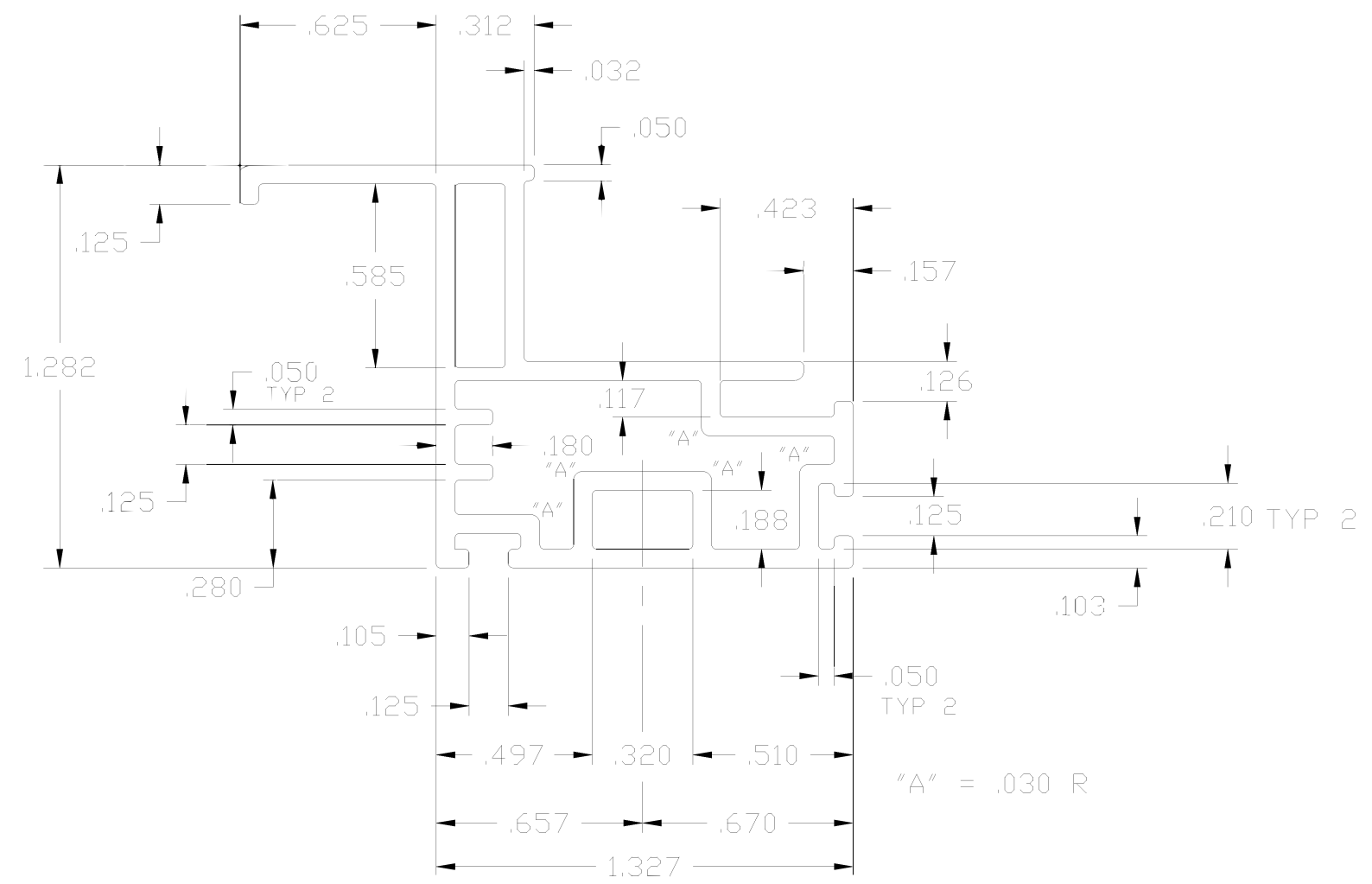
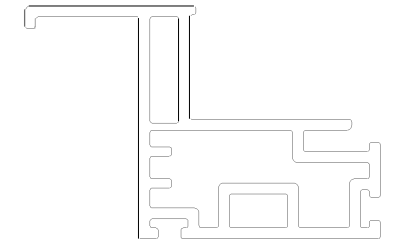

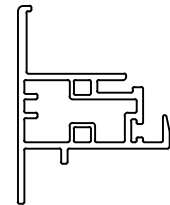
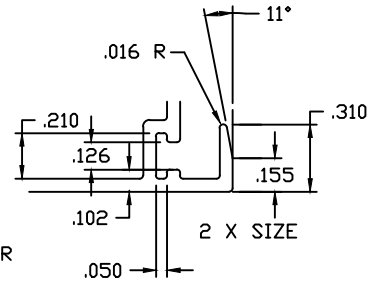
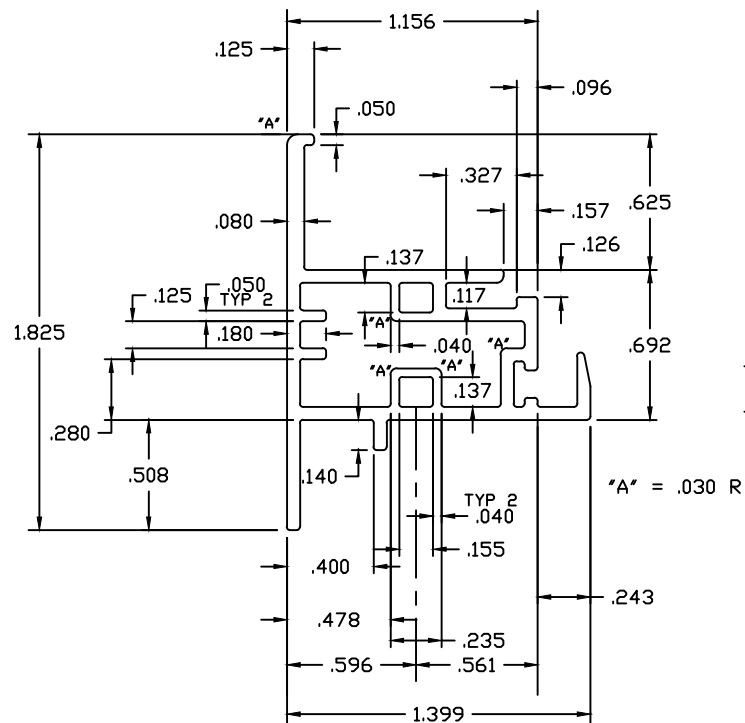

DO NOT SCALE DRAWING

				LOCATION FOR IMPACT TEST SPECIFICATION-LENGTHS TO 3/8"						
				DRAWN FOR QUALITY LINEALS "OUR NAME SAYS IT ALL"	BY DDS DESIGNS	1) MATERIAL RIGID PVC 2) CAPSTOCK 3) UNSPECIFIED WALLS 4) BREAK ALL CORNERS 5) AREA SQ.IN. 6) WT/FT		TITLE SH660 HANDLE SASH		
						.065 R .015 .452 .284 LBS/FT		DWN BY DDS	SCALE 2:1	DATE 1-6-99
						COMPUTER NO				
						DWG NO B-SHSH- 1002				
NO.	REVISION	BY	DATE							



DO NOT SCALE DRAWING

NO.	REVISION	BY	DATE

<input checked="" type="checkbox"/> LOCATION FOR IMPACT TEST SPECIFICATION—LENGTHS TO 3/8"			
DRAWN FOR  BY  DDS DESIGNS "OUR NAME SAYS IT ALL"	1) MATERIAL RIGID PVC 2) CAPSTOCK 3) UNSPECIFIED WALLS 4) BREAK ALL CORNERS .015 R 5) AREA .436 SQ.IN. 6) WT/FT LBS/FT	TITLE SH660 FIXED MEETING RAIL	
	DWN BY DDS	SCALE 2:1	DATE 1-6-99
		DWG NO B-SHMR-1003	

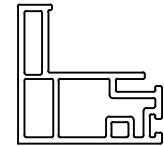
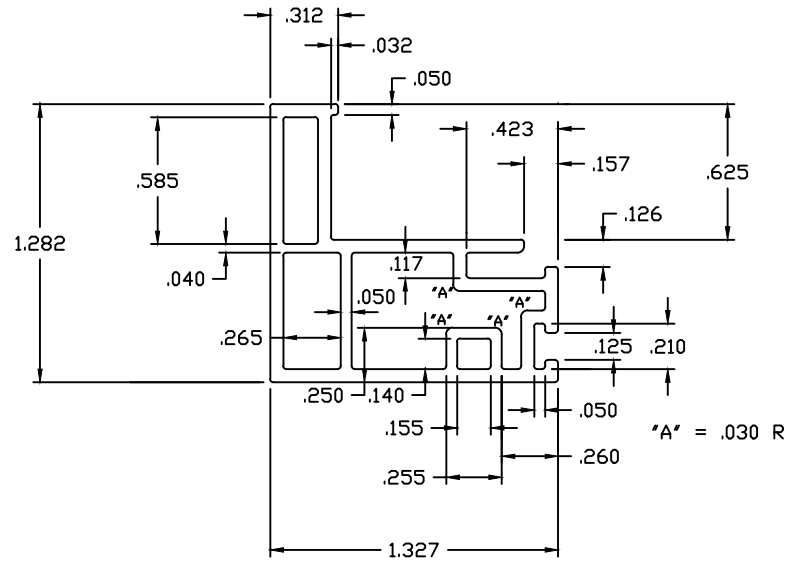

FULL SCALE

DO NOT SCALE DRAWING

NO.	REVISION	BY	DATE

☑ LOCATION FOR IMPACT TEST
SPECIFICATION—LENGTHS TO 3/8"

DRAWN FOR

 BY

 DDS
 DESIGNS
 "OUR NAME SAYS IT ALL"

- 1) MATERIAL RIGID PVC
- 2) CAPSTOCK
- 3) UNSPECIFIED WALLS .065
- 4) BREAK ALL CORNERS .015R
- 5) AREA .407 SQ.IN.
- 6) WT/FT LBS/FT

TITLE SH660
FEMALE

DWN BY DDS	SCALE 2:1	DATE 1-6-99	CHKD BY	APPD BY
COMPUTER NO				

DWG NO B-SHLR-1004

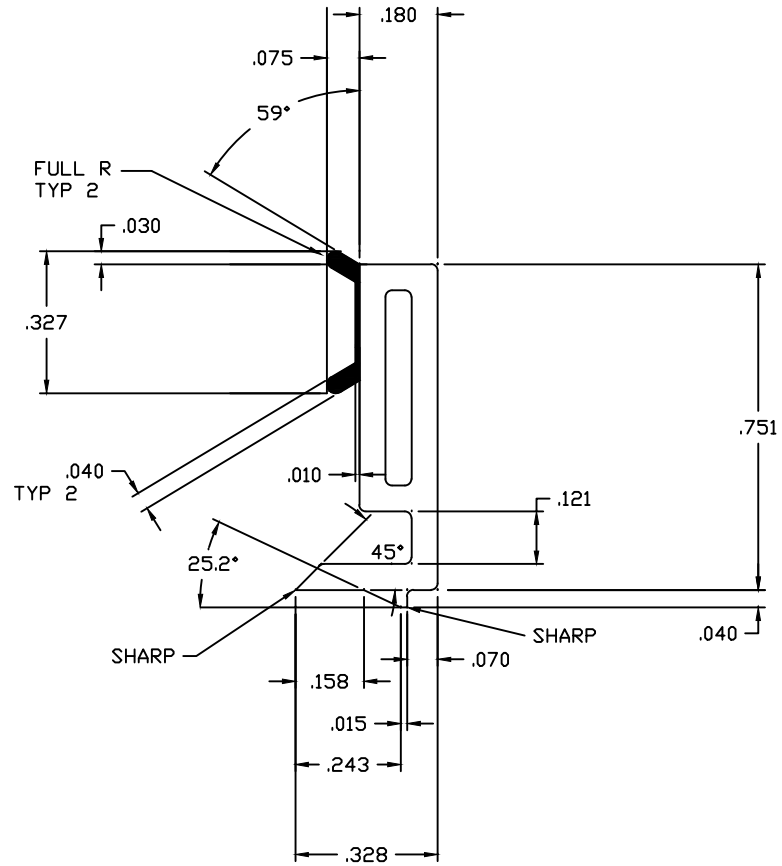



AREA OF RIGID PVC=.105
WT/FT OF RIGID PVC=.066

AREA OF FLEX PVC=.008
WT/FT OF FLEX PVC=.006

TOTAL AREA=.113
TOTAL WT/FT=.071

DO NOT SCALE DRAWING

NO.	REVISION	BY	DATE

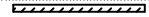
<input checked="" type="checkbox"/> LOCATION FOR IMPACT TEST SPECIFICATION—LENGTHS TO 3/8"			
DRAWN FOR  BY  "OUR NAME SAYS IT ALL"	1) MATERIAL RIGID PVC 2) CAPSTOCK  3) UNSPECIFIED WALLS .060 4) BREAK ALL CORNERS .015R 5) AREA .113 SQ.IN. 6) WT/FT . LBS/FT	TITLE SH660 GLAZING BEAD	
	DWN BY DDS	SCALE 4:1	DATE 1-8-99
		COMPUTER NO	
		DWG NO B-SHG-1008	

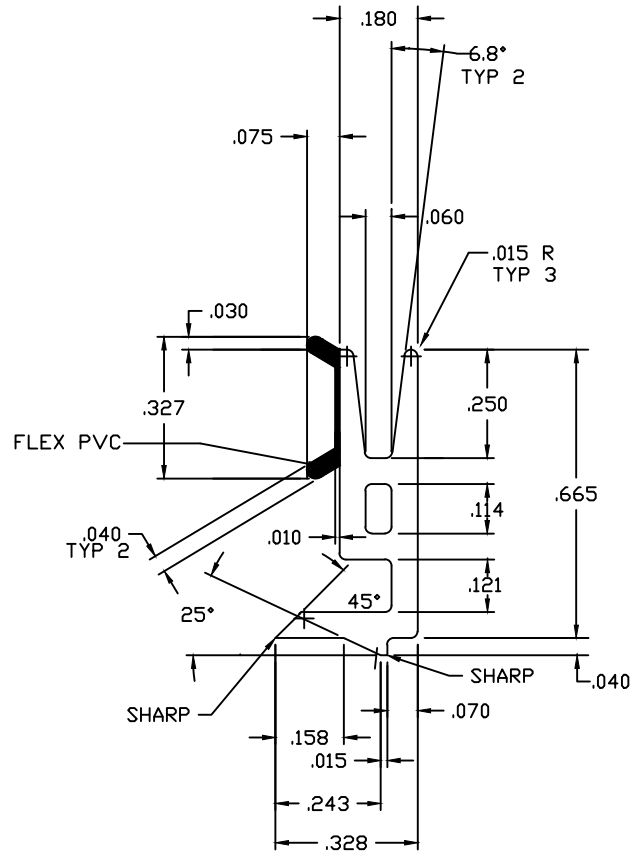

AREA OF RIGID PVC=.085
WT/FT OF RIGID PVC=.054

AREA OF FLEX PVC=.008
WT/FT OF FLEX PVC=.006

DO NOT SCALE DRAWING

NO.	REVISION	BY	DATE

☒ LOCATION FOR IMPACT TEST
SPECIFICATION—LENGTHS TO 3/8"

DRAWN FOR

 QUALITY LINEALS
 BY 
 DDS DESIGNS
 "OUR NAME SAYS IT ALL"

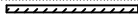
- 1) MATERIAL RIGID PVC
- 2) CAPSTOCK 
- 3) UNSPECIFIED WALLS .060
- 4) BREAK ALL CORNERS .015 R
- 5) AREA .093 SQ.IN.
- 6) WT/FT LBS/FT

TITLE SH660 SH-INTERLOCK GLAZING BEAD				
DWN BY DDS	SCALE 4:1	DATE 1-8-99	CHKD BY	APPD BY
COMPUTER NO				
DWG NO B-SHGI-1009				

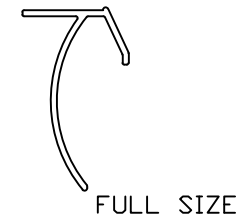
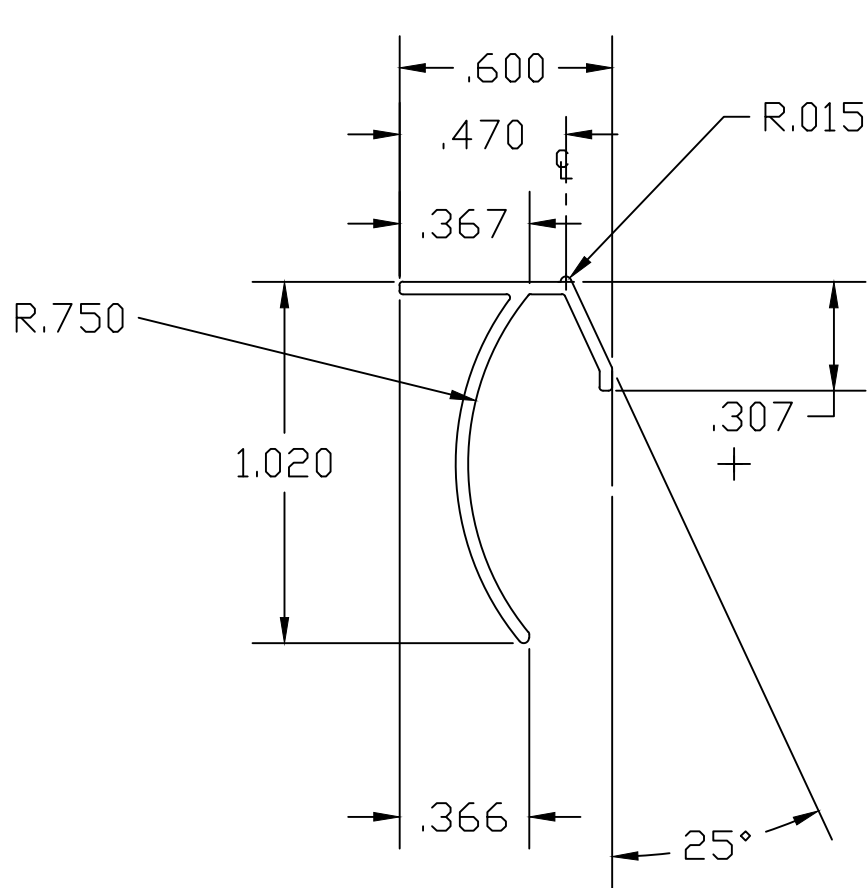

DO NOT SCALE DRAWING

<input checked="" type="checkbox"/> LOCATION FOR IMPACT TEST SPECIFICATION—LENGTHS TO 3/8"		ALLOWABLE BOW MAX. 1" PER 14' ANGULARITY TO BE ± 1/2°			
DRAWN FOR  BY DDS DESIGNS "OUR NAME SAYS IT ALL"		1) MATERIAL RIGID PVC 2) CAPSTOCK 3) UNSPECIFIED WALLS .035 4) BREAK ALL CORNERS .010 R 5) AREA .065 SQ.IN. 6) WT/FT LBS/FT		TITLE SH SCREEN CLIP DWN BY DDS SCALE DATE 02 10 18 CHKD BY APPD BY COMPUTER NO DWG NO	

NO.	REVISION	BY	DATE