



CW390

Casement

New Construction
Nailing Flange Only

3 1/4" Jamb

7/8" Insulated Glass
Welded Assembly

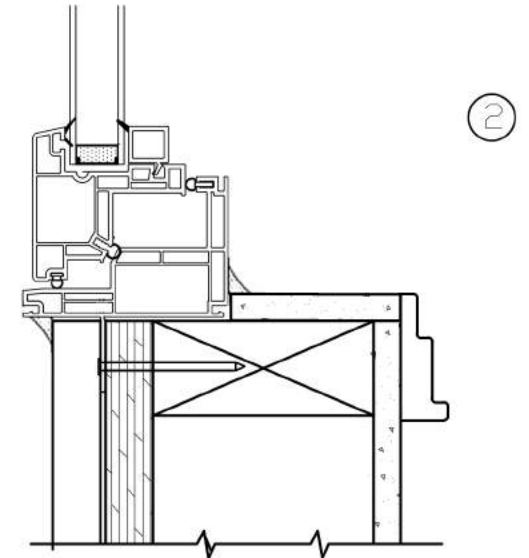
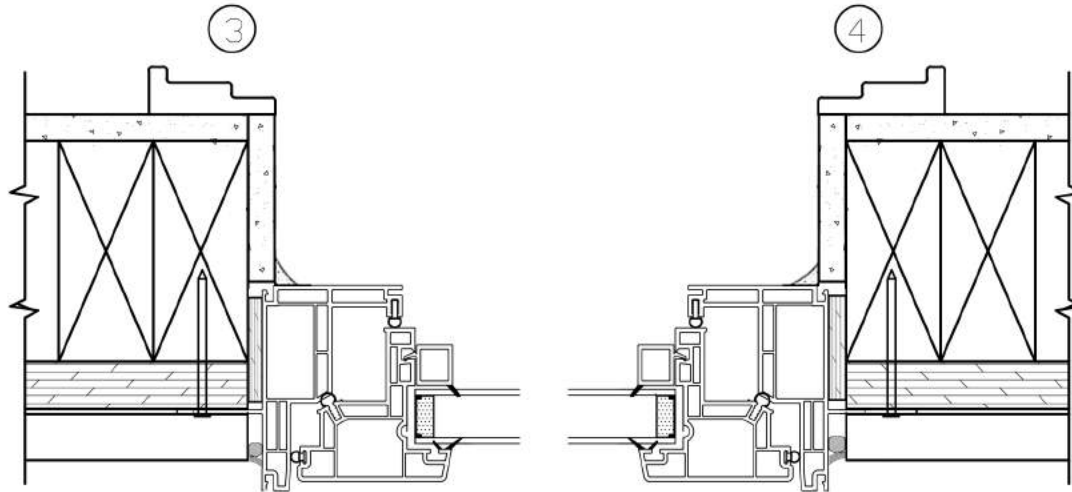
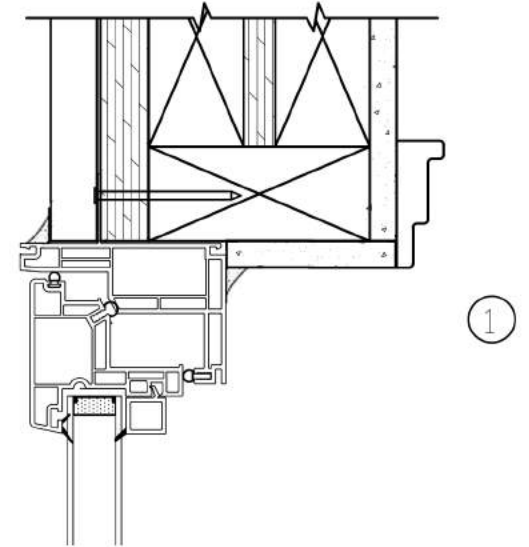
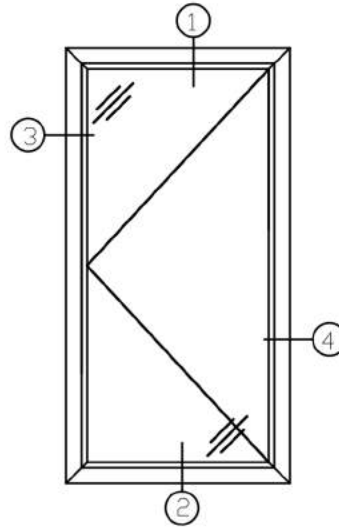

Recommended Installation

Use of Shims & Expansion Foam Recommended As Needed

Actual Installation May Vary Based On Construction Application

Window System Design Property Of Quality Lineals USA, Inc.

NorthEast Windows USA, Inc.
Quality Lineals USA, Inc.

1 Kees Place Merrick, NY 11566

P: 516-378-6577 F: 516-868-3577

WWW.NORTHEASTWINDOWSUSA.COM