

NORTH EAST WINDOWS USA, INC. COMPUTER SIMULATION REPORT

SCOPE OF WORK

100 DOUBLE HUNG - NFRC 100/200/500

REPORT NUMBER

M9790.01-116-45 R0

TEST DATE

01/10/22

ISSUE DATE

01/10/22

RECORD RETENTION END DATE

01/10/27

PAGES

20

DOCUMENT CONTROL NUMBER

RT-R-AMER-Test-4044 (01/16/19)

©2017 INTERTEK

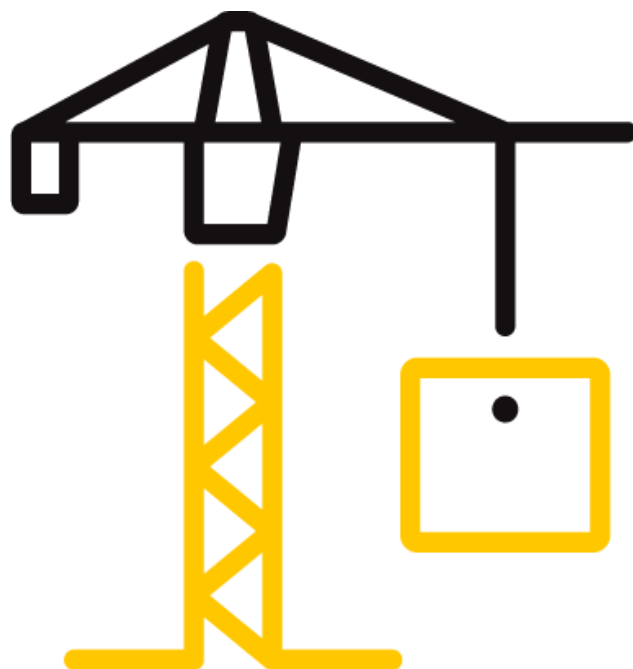

TEST REPORT FOR NORTH EAST WINDOWS USA, INC.

Report No: M9790.01-116-45 R0

Date: 01/10/22

REPORT ISSUED TO

NORTH EAST WINDOWS USA, INC.

One Kes Place

P.O. Box 159

Merrick, New York 11566

SECTION 1

SUMMARY

SERIES/MODEL: 100 Double Hung

Architectural Testing, Inc. (an Intertek company) dba Intertek Building & Construction (B&C) was contracted to perform U-Factor, Solar Heat Gain Coefficient, Visible Transmittance and Condensation Resistance simulations in accordance with the National Fenestration Rating Council (NFRC).

This report does not constitute certification of this product nor an opinion or endorsement by this laboratory. Intertek B&C will service this report for the entire test record retention period. The test record retention period ends five years after the test date. Test records, such as detailed drawings, datasheets, representative samples of test specimens, or other pertinent project documentation, will be retained for the entire test record retention period.

FOR INTERTEK B&C:

COMPLETED BY: Richard A. McVicker III

TITLE: Simulation Technician

SIGNATURE:

DATE: 01/10/22

RAM:ram

REVIEWED BY: Eric S. Leitner

TITLE: Manager - Simulations
and Thermal Testing, SIRC

SIGNATURE:

DATE: 01/10/22

This report is for the exclusive use of Intertek's Client and is provided pursuant to the agreement between Intertek and its Client. Intertek's responsibility and liability are limited to the terms and conditions of the agreement. Intertek assumes no liability to any party, other than to the Client in accordance with the agreement, for any loss, expense or damage occasioned by the use of this report. Only the Client is authorized to permit copying or distribution of this report and then only in its entirety. Any use of the Intertek name or one of its marks for the sale or advertisement of the tested material, product or service must first be approved in writing by Intertek. The observations and test results in this report are relevant only to the sample(s) tested. This report by itself does not imply that the material, product, or service is or has ever been under an Intertek certification program.

TEST REPORT FOR NORTH EAST WINDOWS USA, INC.

Report No: M9790.01-116-45 R0

Date: 01/10/22

SECTION 2

TEST METHODS

The products were evaluated in accordance with the following:

ANSI/NFRC 100-2020, Procedure for Determining Fenestration Product U-Factors

ANSI/NFRC 200-2020, Procedure for Determining Fenestration Product Solar Heat Gain Coefficient and Visible Transmittance at Normal Incidence

NFRC 500-2017, Procedure for Determining Fenestration Product Condensation Resistance Values

**Condensation Resistance results obtained from this procedure are for controlled laboratory conditions and do not include the effects of air movement through the specimen, solar radiation, and the thermal bridging that may occur due to the specific design and construction of the fenestration system opening.*

Ratings values included in this report are for submittals to an NFRC-licensed IA and are not meant to be used directly for labeling purposes. Only those values identified on a valid Certificate of Authorization (CA) by an NFRC accredited Inspection Agency (IA) are to be used for labeling purposes. The ratings values were rounded in accordance with NFRC 601, NFRC Unit and Measurement Policy.

Intertek B&C is an NFRC accredited simulation laboratory and all simulations were conducted in full compliance with NFRC approved procedures and specifications. The values included in this report are not considered in compliance with ANSI/NFRC 100, ANSI/NFRC 200, and/or NFRC 500 unless the associated validation test requirements have been satisfied, as applicable.

TEST REPORT FOR NORTH EAST WINDOWS USA, INC.

Report No: M9790.01-116-45 R0

Date: 01/10/22

SECTION 3

TEST PROCEDURE

The total product, including specific frame, spacer, and glass details, was modeled using NFRC approved software.

FRAME AND EDGE MODELING	THERM 7.4.4
CENTER-OF-GLASS MODELING	WINDOW 7.4.14
TOTAL PRODUCT CALCULATIONS	WINDOW 7.4.14
SPECTRAL DATA LIBRARY	IGDB 83.0

Modeling Assumptions / Technical Interpretations

Any modeling assumptions and technical interpretations required to model this product are listed below.

- 1) To prevent air infiltration, tape was applied to all interior sash crack locations.
- 2) Grids did not require modeling per ANSI/NFRC 100-2017 Section 4.2.4.1.D.ii.a

SECTION 4

SIMULATION SPECIMEN DESCRIPTION

SERIES/MODEL	100 Double Hung
PRODUCT TYPE	Vertical Slider, Double Hung
FRAME MATERIAL	VY - Vinyl
SASH MATERIAL	VY - Vinyl
STANDARD SIZE	1200mm x 1500mm

TEST REPORT FOR NORTH EAST WINDOWS USA, INC.

Report No: M9790.01-116-45 R0

Date: 01/10/22

SECTION 4 (Continued)

SIMULATION SPECIMEN DESCRIPTION

SPACER OPTIONS			
TYPE	PRIMARY SEAL	SECONDARY SEAL	CODE
Quanex Duralite Spacer	Butyl Rubber	-	P1-S

GRID OPTIONS		
GRID SIZE	GRID TYPE	GRID PATTERN
0.188" x 0.625"	Aluminum Rectangular Grid (Painted)	NFRC Standard

REINFORCEMENT OPTIONS	
LOCATION	MATERIAL
-	-

GAS FILLING TECHNIQUE	
FILL TYPE	METHOD
90% Argon	Single Probe

EDGE-OF-GLASS CONSTRUCTION	
INTERIOR CONDITION	Flexible Vinyl Fins Against Glass
EXTERIOR CONDITION	Flexible Vinyl Fins Against Glass

WEATHERSTRIPPING		
TYPE	QUANTITY	LOCATION
Mohair	2 Row	Verical Sash
Mohair	1 Row	Sill Frame, Head Sash & Keeper Rail

FRAME/SASH MATERIALS FINISH	
INTERIOR	Vinyl
EXTERIOR	Vinyl

VALIDATION MATRIX*	
PRODUCT LINE	REPORT NUMBER
None	-

**These products are part of a validation matrix. Only one is required for validation testing.*

TEST REPORT FOR NORTH EAST WINDOWS USA, INC.

Report No: M9790.01-116-45 R0

Date: 01/10/22

SECTION 5

SPECIALTY PRODUCTS TABLE

The specialty products method allows the manufacturer to determine the overall product SHGC and VT for any glazing option. The center of glass SHGC and/or VT must be determined using WINDOW 7.4.14. The method calculates overall product SHGC and VT indexed on center of glass properties. All values used in the calculations are truncated to six decimal place precision.

	No Dividers	Dividers < 1	Dividers > 1
SHGC0	0.003868	0.006592	0.009156
SHGC1	0.751017	0.671083	0.595829
VT0	0.000000	0.000000	0.000000
VT1	0.747149	0.664492	0.586673

$$SHGC = SHGC0 + SHGCc (SHGC1 - SHGC0)$$

$$VT = VT0 + VTc (VT1 - VT0)$$

TEST REPORT FOR NORTH EAST WINDOWS USA, INC.

Report No: M9790.01-116-45 R0

Date: 01/10/22

SECTION 6

SIMULATION RESULTS

TOTAL PRODUCT CALCULATIONS (100 Double Hung)												
Option Number	Pane Thickness 1 (in)	Gap Width 1 (in)	Pane Thickness 2 (in)	Gap Width 2 (in)	Pane Thickness 3 (in)	Gap Width 3 (in)	Pane Thickness 4 (in)	Gap Fill	Low-e (Surface #)	Tint	Spacer	Grid Type
	U-Factor (Btu/Hr-Ft2-F)			Solar Heat Gain Coefficient (SHGC) Grids (None / <1 / >=1)				Visible Transmittance (VT) Grids (None / <1 / >=1)		Condensation Resistance (CR)		
1	CS36/ARG/CLR (SS/SS) 3/4" IG											
	0.090	0.689	0.086					ARG90	0.027(#2)	CL	P1-S	N,G
	U-Factor 0.29			SHGC(N/<1) 0.27 / 0.25				VT(N/<1) 0.50 / 0.45		CR 59		
2	CS36/ARG/CLR (DS/DS) 3/4" IG											
	0.128	0.625	0.123					ARG90	0.027(#2)	CL	P1-S	N,G
	U-Factor 0.29			SHGC(N/<1) 0.27 / 0.24				VT(N/<1) 0.50 / 0.44		CR 62		
3	CS28/ARG/CLR (SS/SS) 3/4" IG											
	0.087	0.689	0.086					ARG90	0.023(#2)	CL	P1-S	N,G
	U-Factor 0.29			SHGC(N/<1) 0.21 / 0.19				VT(N/<1) 0.48 / 0.43		CR 59		
4	CS28/ARG/CLR (DS/DS) 3/4" IG											
	0.125	0.625	0.123					ARG90	0.021(#2)	CL	P1-S	N,G
	U-Factor 0.28			SHGC(N/<1) 0.21 / 0.19				VT(N/<1) 0.47 / 0.42		CR 62		
5	CLR/ARG/CS36 (SS/SS) 3/4" IG											
	0.086	0.689	0.090					ARG90	0.027(#3)	CL	P1-S	N,G
	U-Factor 0.29			SHGC(N/<1) 0.36 / 0.33				VT(N/<1) 0.50 / 0.45		CR 59		
6	CLR/ARG/CS36 (DS/DS) 3/4" IG											
	0.123	0.625	0.128					ARG90	0.027(#3)	CL	P1-S	N,G
	U-Factor 0.29			SHGC(N/<1) 0.36 / 0.32				VT(N/<1) 0.50 / 0.44		CR 62		
7	CLR/ARG/CS28 (SS/SS) 3/4" IG											
	0.086	0.689	0.087					ARG90	0.023(#3)	CL	P1-S	N,G
	U-Factor 0.29			SHGC(N/<1) 0.30 / 0.27				VT(N/<1) 0.48 / 0.43		CR 59		
8	CLR/ARG/CS28 (DS/DS) 3/4" IG											
	0.123	0.625	0.125					ARG90	0.021(#3)	CL	P1-S	N,G
	U-Factor 0.28			SHGC(N/<1) 0.30 / 0.27				VT(N/<1) 0.47 / 0.42		CR 62		
9	7036/ARG/CLR (SS/SS) 3/4" IG											
	0.090	0.689	0.090					ARG90	0.036(#2)	CL	P1-S	N,G
	U-Factor 0.29			SHGC(N/<1) 0.29 / 0.26				VT(N/<1) 0.53 / 0.47		CR 59		
10	7036/ARG/CLR (DS/DS) 3/4" IG											
	0.117	0.625	0.117					ARG90	0.036(#2)	CL	P1-S	N,G
	U-Factor 0.29			SHGC(N/<1) 0.29 / 0.26				VT(N/<1) 0.52 / 0.47		CR 62		

TEST REPORT FOR NORTH EAST WINDOWS USA, INC.

Report No: M9790.01-116-45 R0

Date: 01/10/22

SECTION 6 (Continued)

SIMULATION RESULTS

TOTAL PRODUCT CALCULATIONS (100 Double Hung)												
Option Number	Pane Thickness 1 (in)	Gap Width 1 (in)	Pane Thickness 2 (in)	Gap Width 2 (in)	Pane Thickness 3 (in)	Gap Width 3 (in)	Pane Thickness 4 (in)	Gap Fill	Low-e (Surface #)	Tint	Spacer	Grid Type
	U-Factor (Btu/Hr-Ft ² -F)		Solar Heat Gain Coefficient (SHGC) Grids (None / <1 / >=1)				Visible Transmittance (VT) Grids (None / <1 / >=1)		Condensation Resistance (CR)			
11	CLR/ARG/7036 (SS/SS) 3/4" IG											
	0.090	0.689	0.090					ARG90	0.036(#3)	CL	P1-S	N,G
	U-Factor 0.29		SHGC(N/<1) 0.37 / 0.33				VT(N/<1) 0.53 / 0.47		CR 59			
12	CLR/ARG/7036 (DS/DS) 3/4" IG											
	0.117	0.625	0.117					ARG90	0.036(#3)	CL	P1-S	N,G
	U-Factor 0.29		SHGC(N/<1) 0.37 / 0.33				VT(N/<1) 0.52 / 0.47		CR 62			



Total Quality. Assured.

130 Derry Court
York, Pennsylvania 17406

Telephone: 717-764-7700
Facsimile: 717-764-4129
www.intertek.com/building

TEST REPORT FOR NORTH EAST WINDOWS USA, INC.

Report No: M9790.01-116-45 R0

Date: 01/10/22

SECTION 7

DRAWINGS / BILL OF MATERIALS

The drawings which follow have been reviewed by Intertek B&C and are representative of the simulation results reported herein. Any deviations are documented herein or on the drawings.



Report #: M9790-116-45

Date: 1/10/2022

Verified by: *Richard A. McVicker III*
Digitally Signed by: Richard A. McVicker III

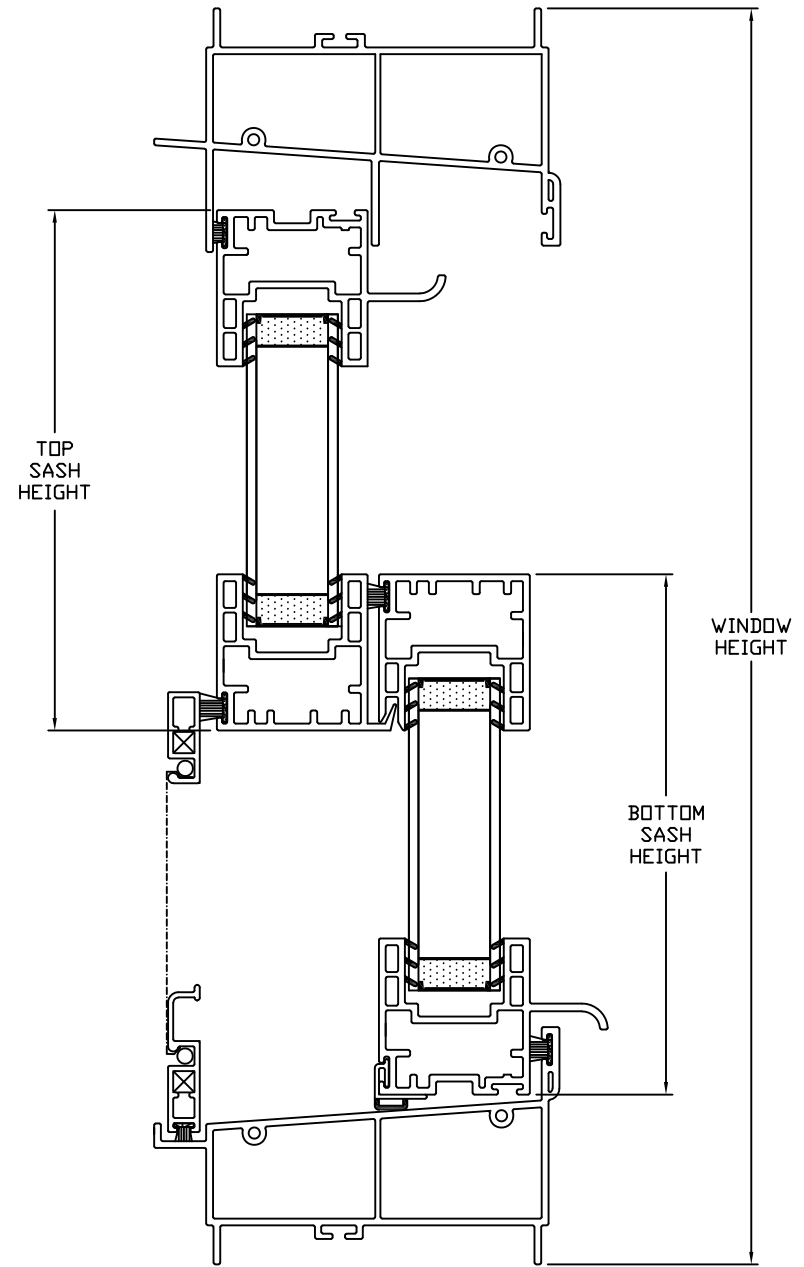
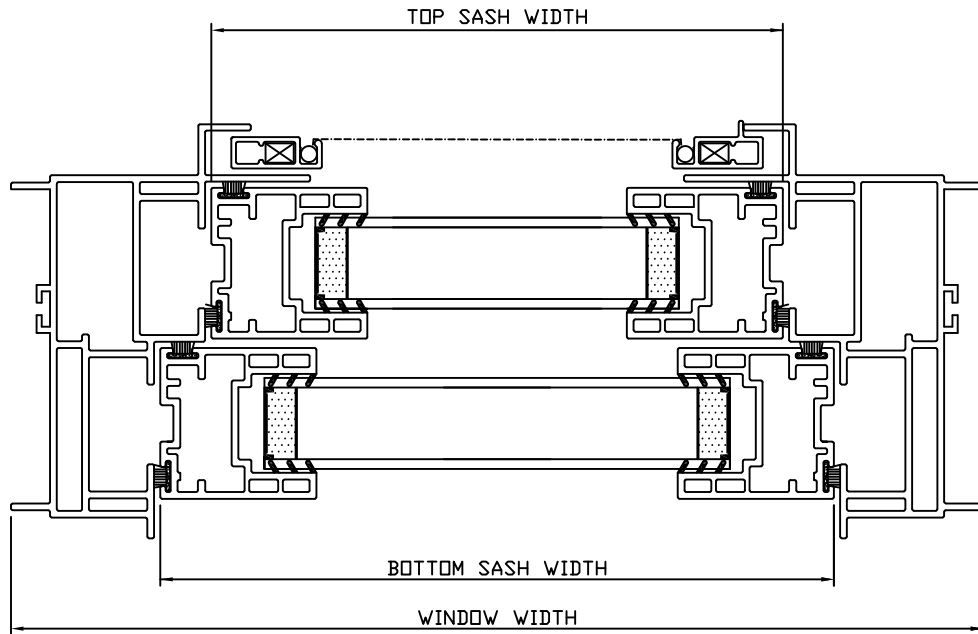

DO NOT SCALE DRAWING

				LOCATION FOR IMPACT TEST SPECIFICATION-LENGTHS TO 3/8"		ALLOWABLE BOW MAX. 1" PER 14" ANGULARITY TO BE ± 1/2			
		DRAWN FOR QUALITY LINEALS BY DDS DESIGNS "OUR NAME SAYS IT ALL"		1) MATERIAL RIGID PVC 2) CAPSTOCK 3) UNSPECIFIED WALLS 4) BREAK ALL CORNERS 5) AREA SQ.IN. R .015 6) WT/FT LBS/FT		TITLESERIES DH 100 MECH MAIN FRAME/MECH SASH		DWN BY DDS SCALE DATE 10/4/03 CHKD BY APPD BY	
NO.		REVISION		BY		DATE		COMPUTER NO DWG NO C-100 DH CROSS SECTION	



Report #: M9790-116-45

Date: 1/10/2022

Verified by: *Rick L. ...*

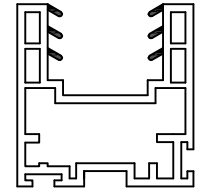
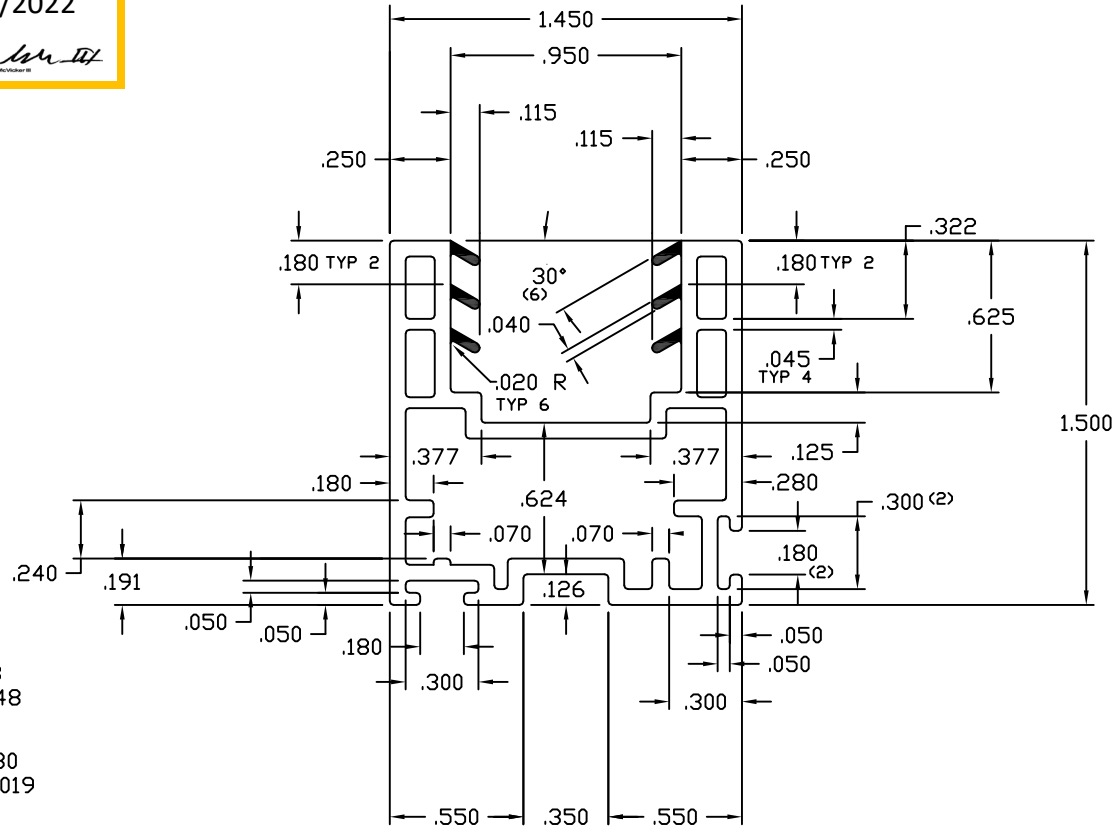

AREA OF RIGID PVC = .553
WT/FT OF RIGID PVC = .348

AREA OF FLEXIBLE PVC = .030
WT/FT OF FLEXIBLE PVC = .019

				LOCATION FOR IMPACT TEST SPECIFICATION-LENGTHS TO 3/8"		ALLOWABLE BOW MAX. 1" PER 14' ANGULARITY TO BE ± 1/2			
				DRAWN FOR  BY DDS DESIGNS		1) MATERIAL RIGID PVC 2) CAPSTOCK 3) UNSPECIFIED WALLS 4) BREAK ALL CORNERS 5) AREA 6) WT/FT		TITLE MECHANICAL DOUBLE HUNG REGULAR SASH	
						.065 R .015 SQ IN .383 LBS/FT .367		DWN BY DDS SCALE FULL DATE 11/16/02 CHKD BY APPD BY	
				"OUR NAME SAYS IT ALL"				COMPUTER NO	
NO. REVISION BY DATE								DWG NO B-DHDS-2000	



Report #: M9790-116-45

Date: 1/10/2022

Verified by: *Richard A. McVicker III*

Digitally Signed by: Richard A. McVicker III

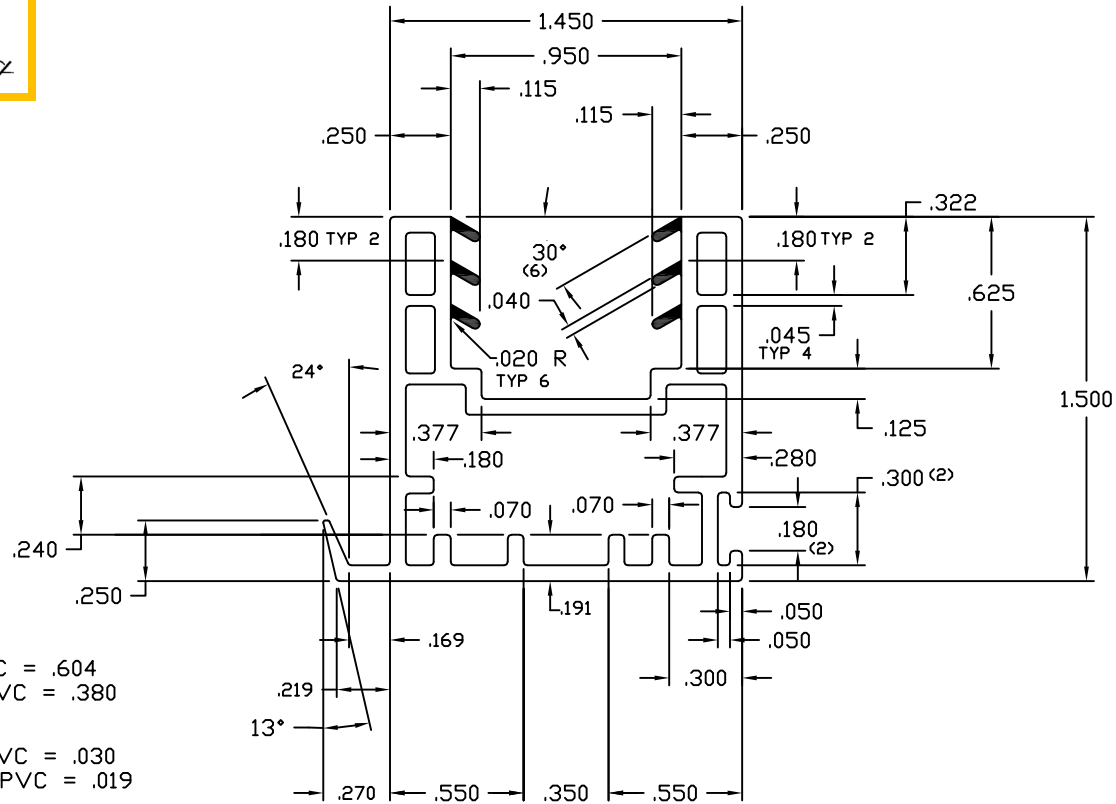

AREA OF RIGID PVC = .604
WT/FT OF RIGID PVC = .380

AREA OF FLEXIBLE PVC = .030
WT/FT OF FLEXIBLE PVC = .019

DO NOT SCALE DRAWING

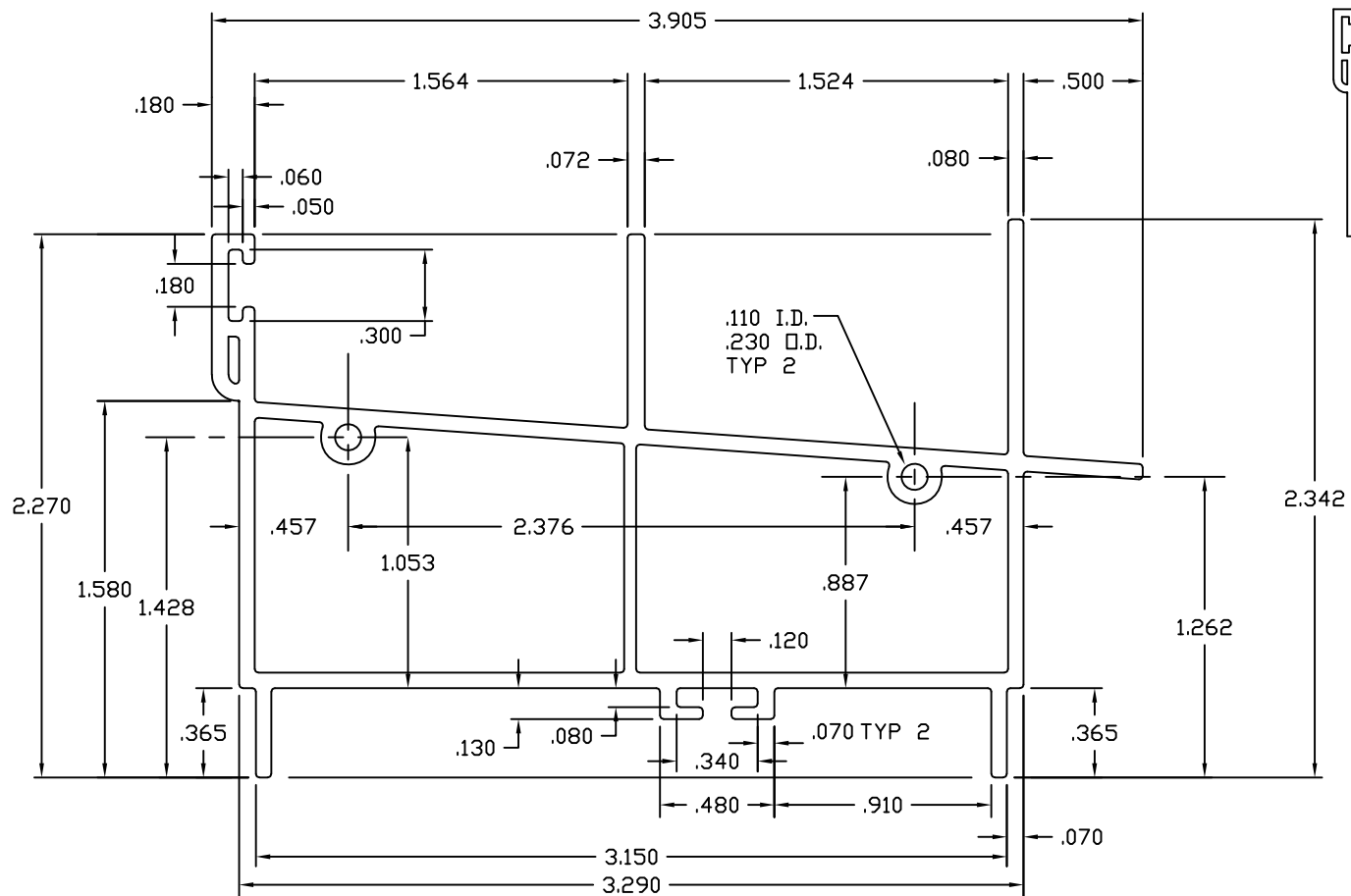

				<input checked="" type="checkbox"/> LOCATION FOR IMPACT TEST SPECIFICATION-LENGTHS TO 3/8"		ALLOWABLE BOW MAX. 1" PER 14' ANGULARITY TO BE ± 1/2			
				DRAWN FOR  QUALITY LINEALS BY DDS DESIGNS "OUR NAME SAYS IT ALL"		1) MATERIAL RIGID PVC 2) CAPSTOCK 3) UNSPECIFIED WALLS 4) BREAK ALL CORNERS R .065 5) AREA SQ. IN .015 6) WT/FT LBS/FT .399		TITLE MECHANICAL DOUBLE HUNG INTERLOCK MALE-KEEPER RAIL	
				DWN BY DDS SCALE FULL DATE 11/16/02 CHKD BY APPD BY					
						COMPUTER NO			
						DWG NO B-DHIM-2004			
NO.	REVISION			BY	DATE				





Report #: M9790-116-45
 Date: 1/10/2022
 Verified by: *Rick A. Sam...*

DO NOT SCALE DRAWING

NO.	REVISION	BY	DATE

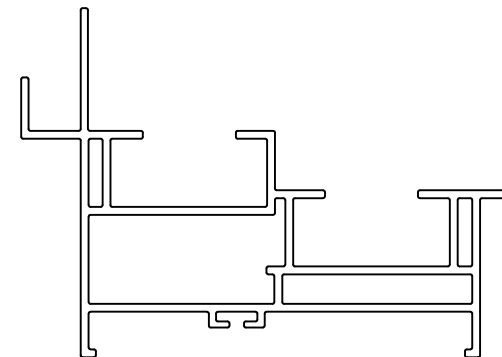
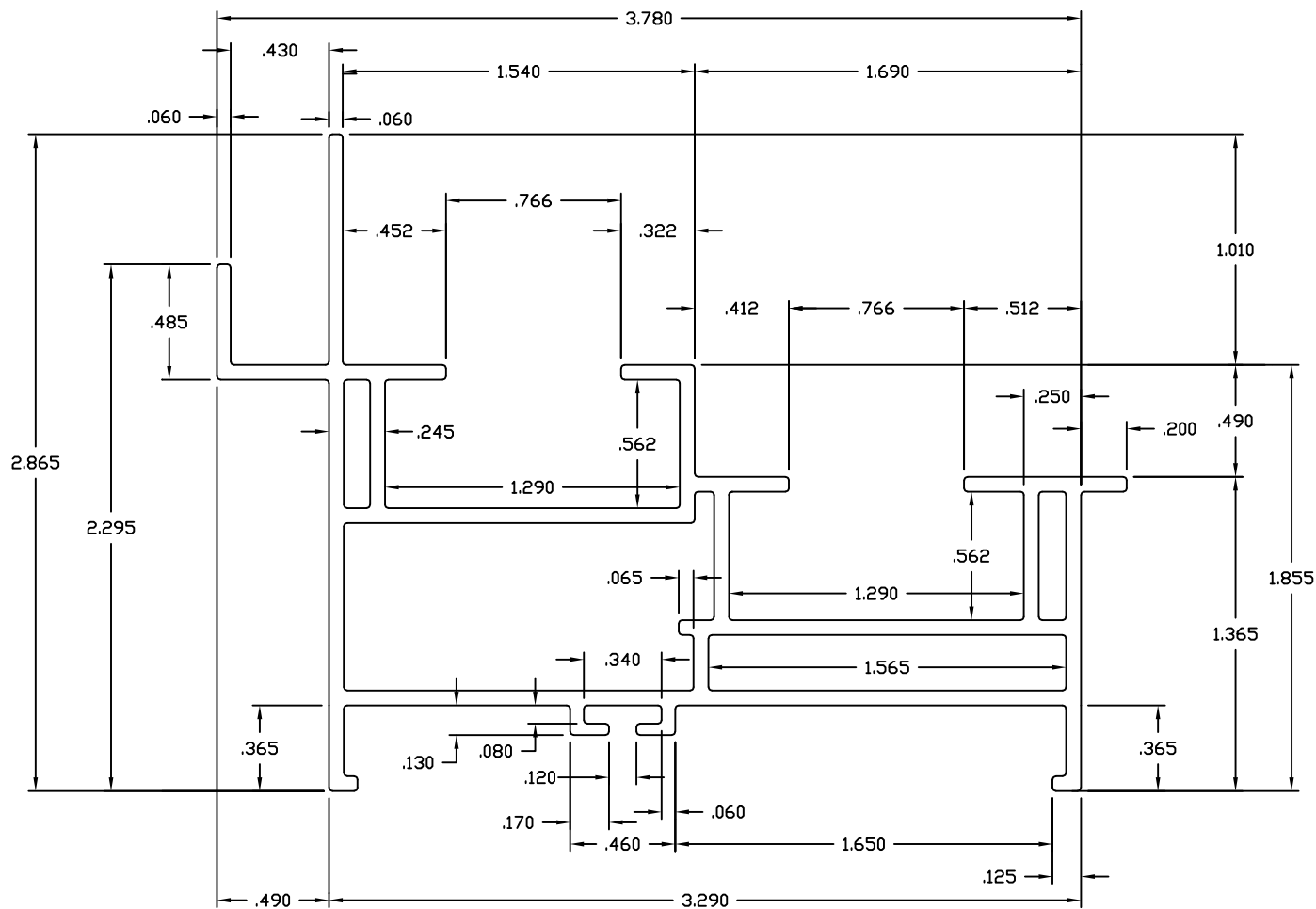

 LOCATION FOR IMPACT TEST SPECIFICATION-LENGTHS TO 3/8"	ALLOWABLE BOW MAX. 1" PER 14' ANGULARITY TO BE ± 1/2	TITLE MECHANICAL DOUBLE HUNG MASTER HEAD	
DRAWN FOR 	BY 	1) MATERIAL RIGID PVC 2) CAPSTOCK 3) UNSPECIFIED WALLS 4) BREAK ALL CORNERS R ¹ .065 5) AREA SQ IN .939 6) WT/FT LBS/FT .603	DWN BY DDS SCALE 2:1 DATE 11/13/02 CHKD BY APPD BY COMPUTER NO DWG NO B-DHMH- 2011
"OUR NAME SAYS IT ALL"			



intertek Report #: M9790-116-45
 Date: 1/10/2022
 Verified by: *Richard A. [Signature]*

DO NOT SCALE DRAWING

NO.	REVISION	BY	DATE

 LOCATION FOR IMPACT TEST SPECIFICATION-LENGTHS TO 3/8"	ALLOWABLE BOW MAX. 1" PER 14' ANGULARITY TO BE ± 1/2	TITLE MECHANICAL DOUBLE HUNG NEW JAMB	
DRAWN FOR 	BY 	1) MATERIAL RIGID PVC 2) CAPSTOCK 3) UNSPECIFIED WALLS 4) BREAK ALL CORNERS R .065 5) AREA SQ IN .015 6) WT/FT LBS/FT .636	DWN BY DDS SCALE 2:1 DATE 11/19/02 CHKD BY APPD BY COMPUTER NO DWG NO B-DHMJN-2018
"OUR NAME SAYS IT ALL"		QUALITY LINEALS	



Report #: M9790-116-45

Date: 1/10/2022

Verified by: *Richard A. [Signature]*

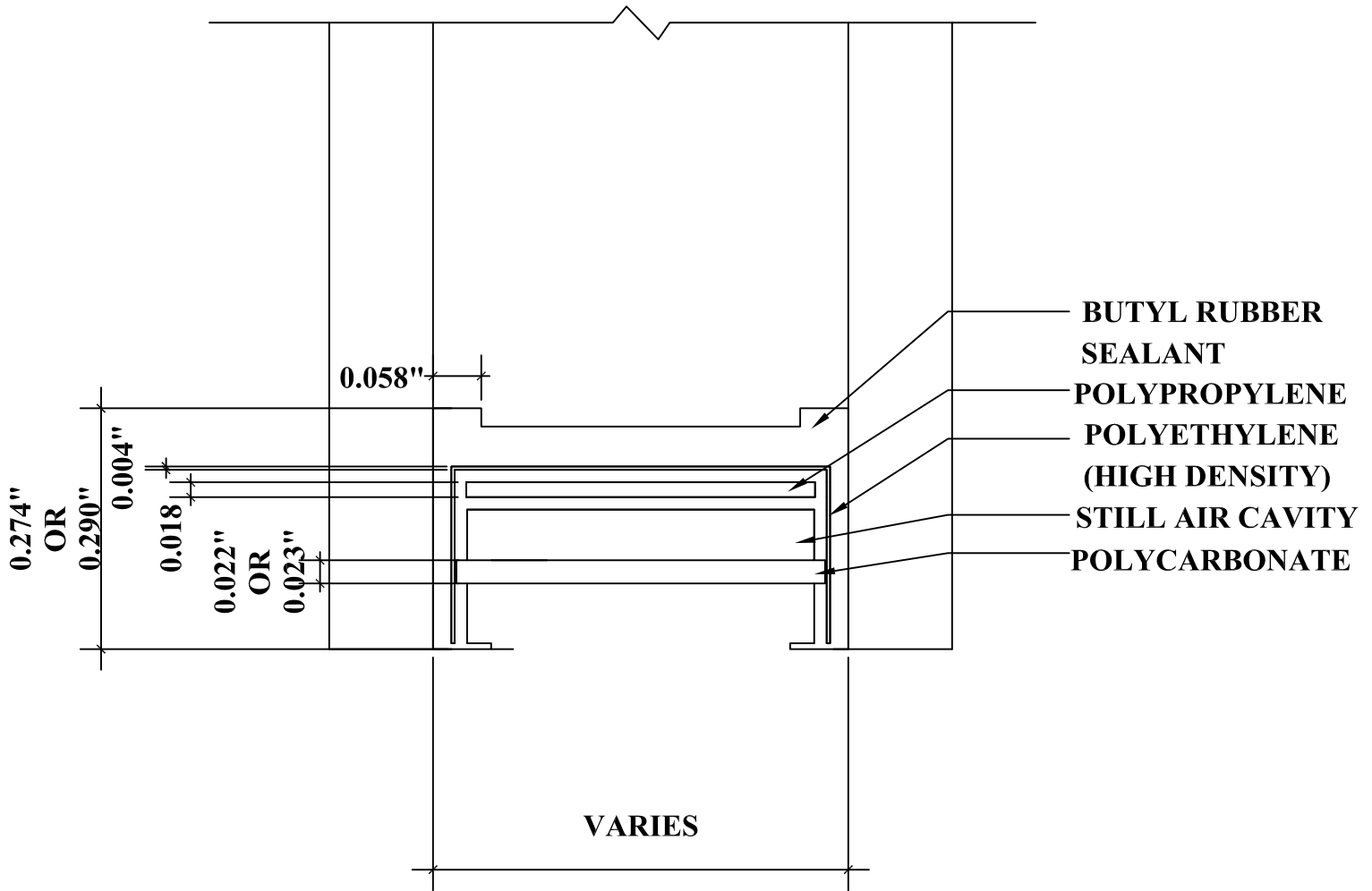

DETAIL FOR THERMAL MODELING OF
QUANEX DURALITE SPACER (P1-S)

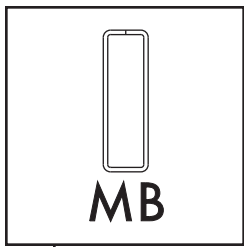

Muntin Bar

Aluminum: Painted, ~~Mill Finish, Clear & Color In™ Anodized~~

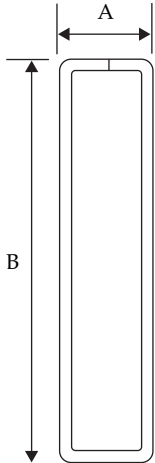

TOLERANCE
 A, ± .005 (.127mm)
 B, ± .005 (.127mm)

SPECIAL NOTICE
Cleaning and Handling of Muntin Bar

We recommend muntin bar to be wiped clean before installation into an insulating glass unit. A household grade liquid cleaner may be used for this purpose.

To avoid breakdown of painted surfaces, do not use M.E.K., Triethane, Alcohol or like substances for the cleaning of painted muntin bar.

When machining and processing muntin bar in your plant, keep saw tables and work areas free of saw cut filings to avoid scratching the painted surfaces.

Packaging Information			
Muntin Bar Size	Part #	Pieces Per Shipping Carton 12' 8" Lengths	Lineal Feet Per Shipping Carton 12' 8" Lengths
1/8 x .610	219697	200	2533
3/16 x 9/16 [†]	119320	150	1900
3/16 x .610 [†]	119705	125	1583
3/16 x 5/8 [†]	120874	125	1583
3/16 x 3/4	122909	110	1393
3/16 x 13/16	123618	110	1393
3/16 x 1	123823	85	1076
1/4 x 9/16	119427	135	1710
1/4 x 5/8 [†]	121410	120	1520
1/4 x 3/4	123063	95	1203
1/4 x 13/16	215017	95	1203
1/4 x 1	123836	70	887
1/4 x 1 1/4	123856	51	646
5/16 x 1	210318	60	684
3/8 x 5/8	121468	90	1140
3/8 x 3/4	123088	75	950
3/8 x 13/16	215016	70	887
3/8 x 7/8	123797	55	697
3/8 x 1	201968	55	696
3/8(.375) x 3/8	205591	140	1773
7/16 x 3/8	119016	115	1457
7/16 x 3/8	216500**	115	1457
7/16 x 1/2	213045	88	1115
7/16 x 5/8 ^Δ	214621	65	823
1/2 x 3/4 [*]	201043	50	633
1/2 x 1	203710	40	506

Specification In Inches		
Muntin Bar Size	A	B
1/8 x .610	.125	.610
3/16 x 9/16 [†]	.187	.551
3/16 x .610 [†]	.187	.610
3/16 x 5/8 [†]	.187	.630
3/16 x 3/4 [†]	.187	.775
3/16 x 13/16 [†]	.187	.801
3/16 x 1	.187	1.000
1/4 x 9/16	.235	.562
1/4 x 5/8 [†]	.235	.625
1/4 x 3/4	.235	.765
1/4 x 13/16	.235	.801
1/4 x 1	.235	1.000
1/4 x 1 1/4	.235	1.250
5/16 x 1	.312	1.000
3/8 x 5/8 [†]	.325	.625
3/8 x 3/4	.325	.750
3/8 x 13/16	.325	.801
3/8 x 7/8	.325	.875
3/8 x 1	.325	1.000
3/8(.375) x 3/8	.375	.375
7/16 x 3/8	.438	.375
7/16 x 3/8	.438	.375
7/16 x 1/2	.438	.500
7/16 x 5/8 ^Δ	.438	.625
1/2 x 3/4 [*]	.500	.750
1/2 x 1	.500	1.000

Part numbers shown are standard white color.

Material thickness: .0185

[†] Available in tutone. Please see Color Selection Chart located in front of catalog.

^Δ Part number shown is Dark Bronze Anodized Color.

^{*} Part number shown is Clear Anodized. ^{**}Part number shown is white welded.

Note: Available in pre-cut lengths and pre-notched; tutone and post-painted. Custom colors also available.



Total Quality. Assured.

130 Derry Court
York, Pennsylvania 17406

Telephone: 717-764-7700
Facsimile: 717-764-4129
www.intertek.com/building

TEST REPORT FOR NORTH EAST WINDOWS USA, INC.

Report No: M9790.01-116-45 R0

Date: 01/10/22

SECTION 8

REVISION LOG

REVISION #	DATE	PAGES	REVISION
.01R0	01/10/22	All	Original report issue.