

DO NOT SCALE DRAWING

NO.	REVISION	BY	DATE

 <p>QUALITY LINEALS BY DDS DESIGNS "OUR NAME SAYS IT ALL"</p>	<p>LOCATION FOR IMPACT TEST ALLOWABLE BOW MAX. 1" PER 14" SPECIFICATION-LENGTHS TO 3/8" ANGULARITY TO BE ± 1/2°</p>	<p>TOLERANCES- XX ± .010 .XXX ± .005</p>
	<p>1) MATERIAL RIGID PVC 2) CAPSTOCK 3) UNSPECIFIED WALLS 4) BREAK ALL CORNERS .015 R 5) AREA S.O.I.N. 6) WT/FT LBS/FT.</p>	<p>TITLE SERIES 990-DOUBLE HUNG WELDED MAIN FRAME / WELDED SASH FIN & J with SNAP IN SILL</p>
<p>DWN BY DDS COMPUTER NO</p>	<p>SCALE DATE 12/21/11 CHKD BY APPD BY</p>	<p>DWG NO C- 990 DH CROSS SECTION</p>

SERIES DH990-WELDED MF w/SNAP IN SILL - WELDED SASH

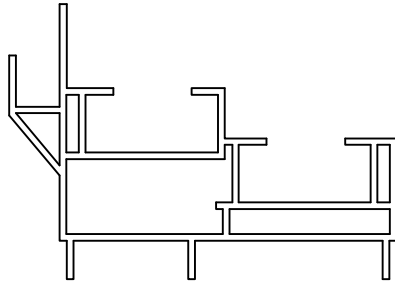

**3012
MAIN FRAME-JAMB STANDARD
WELDED**

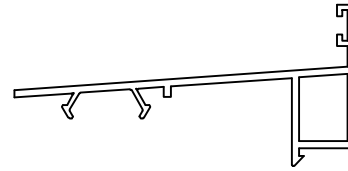

**3006
MAIN FRAME-SNAP IN SILL
WELDED**

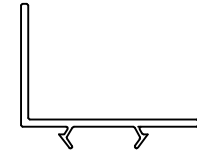

**3005
HEAD ADAPTOR**

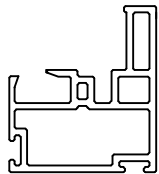

**3000
PLAIN SASH
WELDED**

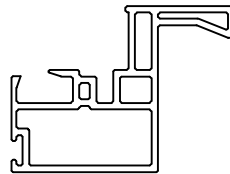

**3002
HANDLE SASH
WELDED**

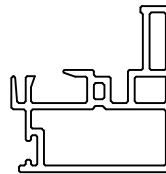

**3003
INTERLOCK FEMALE
WELDED**

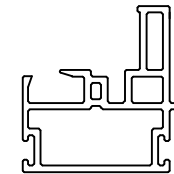

**3004
INTERLOCK MALE
WELDED**



**3008
GLAZING BEAD
WELDED**

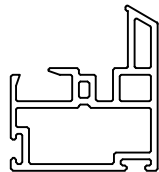

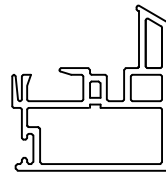

**3000B
PLAIN SASH-BEVELED
WELDED**

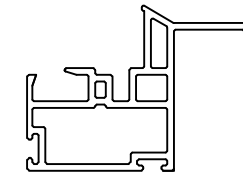

**3003B
INTERLOCK FEMALE-BEVELED
WELDED**



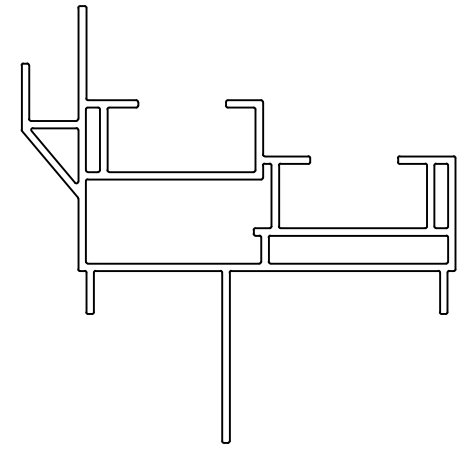
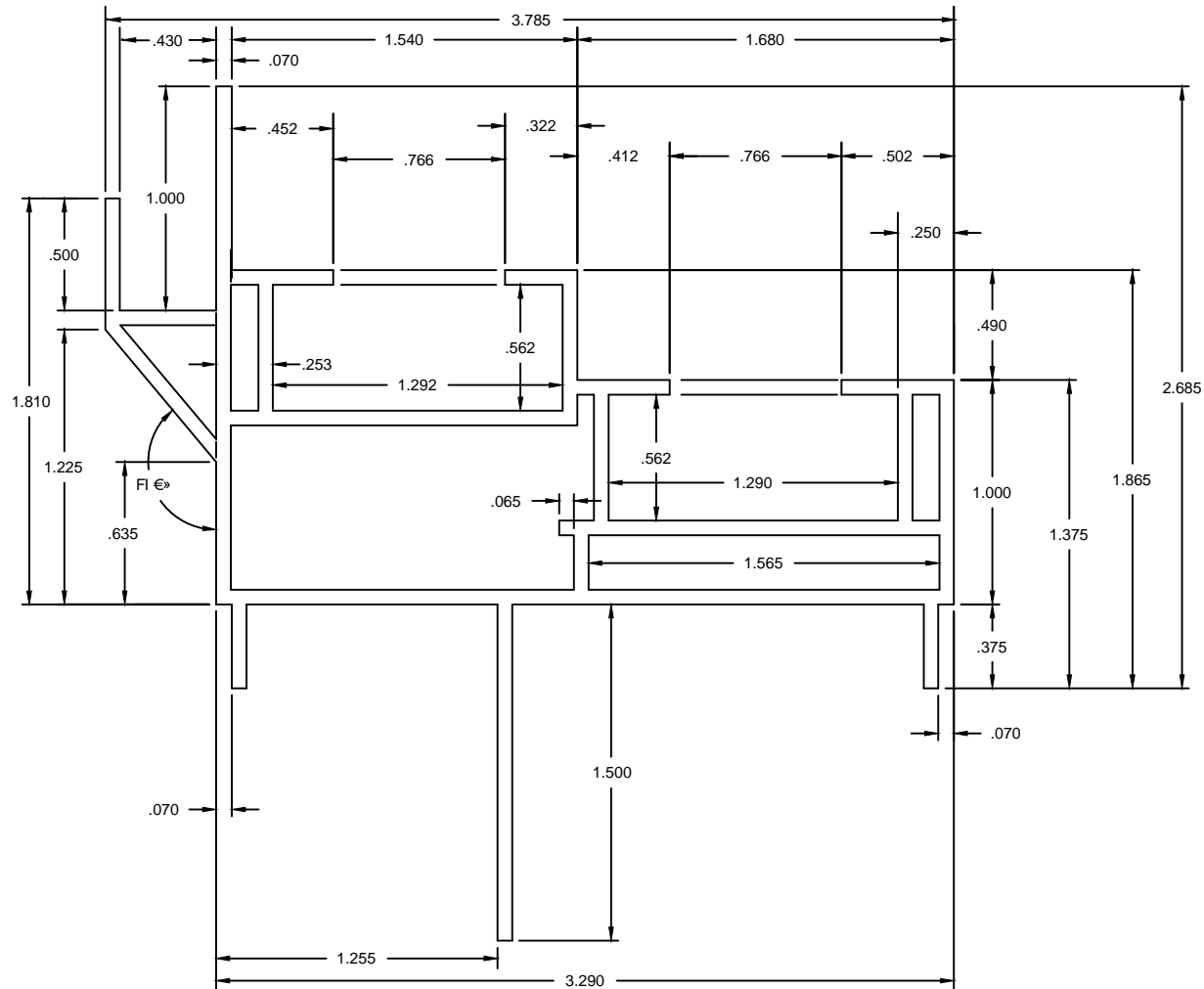

**3001
HANDLE SASH-BEVELED
WELDED**

DRAWN FOR  QUALITY LINEALS BY  DDS DESIGNS 'OUR NAME SAYS IT ALL'	TITLE SERIES DH990 W/SNAP IN SILL WELDED MAIN FRAME-WELDED SASH				
	DWN BY DDS	SCALE	DATE 09-2-11	CHKD BY	APPD BY
	COMPUTER NO				
DWG NO DH990 PROFILE CHART					

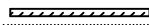

DO NOT SCALE DRAWING

<input checked="" type="checkbox"/> LOCATION FOR IMPACT TEST SPECIFICATION-LENGTHS TO 3/8"		ALLOWABLE BOW MAX. 1" PER 14' ANGULARITY TO BE ± 1/2°		TOLERANCES- .XX ± .010 .XXX ± .005	
DRAWN FOR  BY  "OUR NAME SAYS IT ALL"	1) MATERIAL RIGID PVC 2) CAPSTOCK  3) UNSPECIFIED WALLS .065 4) BREAK ALL CORNERS .015 R 5) AREA 1.162 SQ. IN. 6) WT/FT LBS/FT		TITLE WELDED DOUBLE HUNG JAMB WITH FIN, NO J		
	DWN BY DDS SCALE 2:1 DATE 11/14/02 CHKD BY APPD BY COMPUTER NO		DWG NO B-WDMFF-3612		

NO.	REVISION	BY	DATE

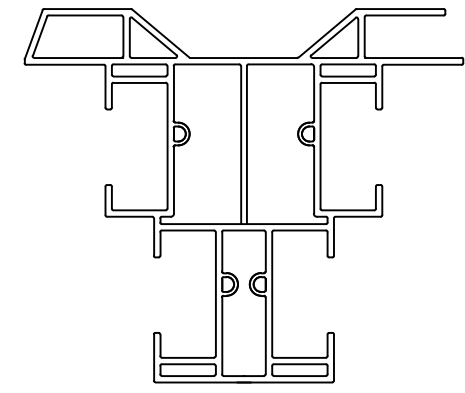
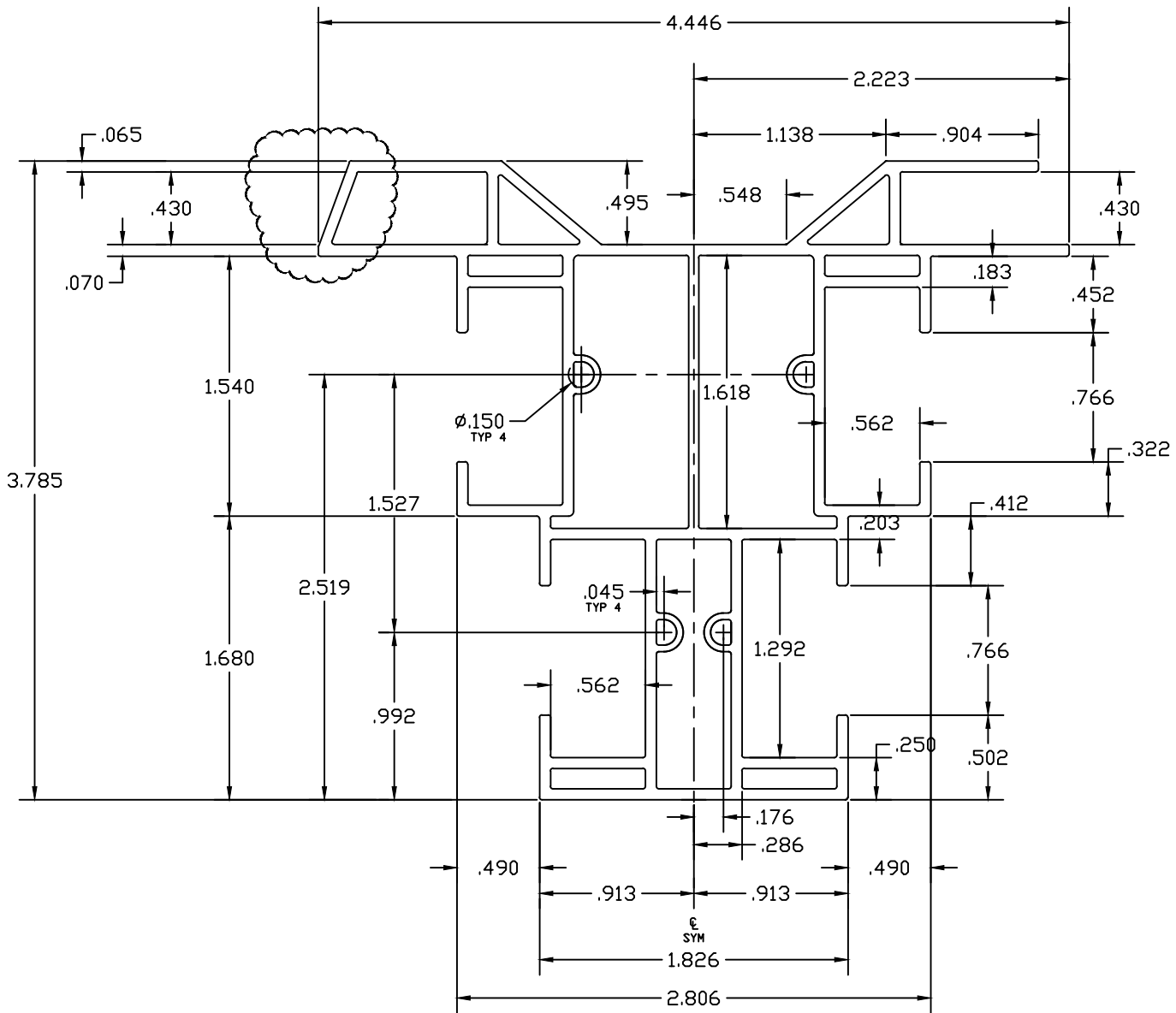

DO NOT SCALE DRAWING

1	ADDED WALL, REVISED WT/FT	DDS	12 10 19
NO.	REVISION	BY	DATE

LOCATION FOR IMPACT TEST SPECIFICATION—LENGTHS TO 3/8"		ALLOWABLE BOW MAX. 1" PER 14' ANGULARITY TO BE ± 1/2°	
DRAWN FOR QUALITY LINEALS BY DDS DESIGNS "OUR NAME SAYS IT ALL"	1) MATERIAL RIGID PVC 2) CAPSTOCK 3) UNSPECIFIED WALLS .065 4) BREAK ALL CORNERS .015 R 5) AREA 1.783 SQ.IN. 6) WT/FT LBS/FT		TITLE DH 900 T-MULLION
	DWN BY DDS	SCALE 2:1	DATE 05/29/19

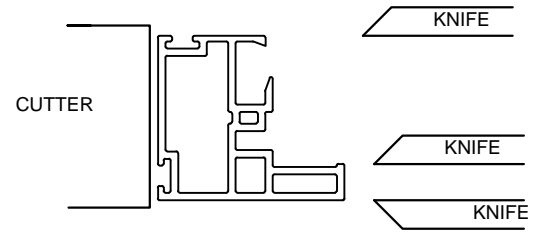
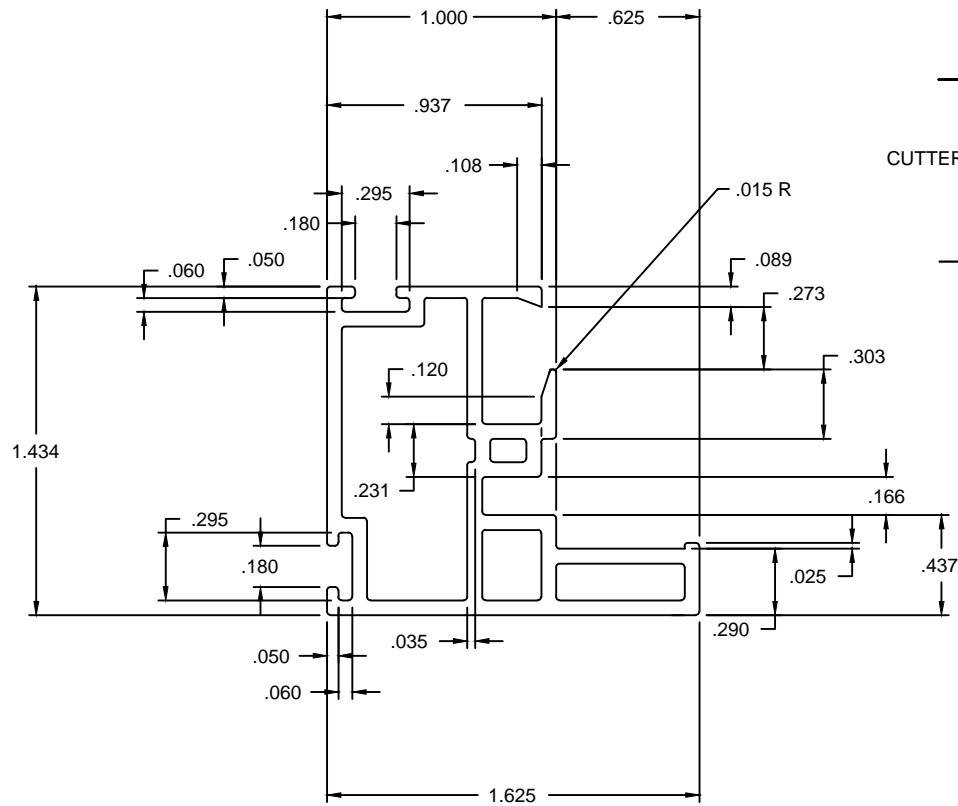

DO NOT SCALE DRAWING

☒ LOCATION FOR IMPACT TEST
SPECIFICATION—LENGTHS TO 3/8"

ALLOWABLE BOW MAX. 1" PER 14'
ANGULARITY TO BE ± 1/2

DRAWN FOR

BY DDS
DESIGNS

"OUR NAME SAYS IT ALL"

- 1) MATERIAL RIGID PVC
- 2) CAPSTOCK
- 3) UNSPECIFIED WALLS .065
- 4) BREAK ALL CORNERS .015
- 5) AREA .509 SQ.IN.
- 6) WT/FT LBS/FT

TITLE WELDED DOUBLE HUNG REGULAR SASH				
DWN BY DDS R	SCALE 2:1	DATE 11/13/02	CHKD BY	APPD BY
COMPUTER NO				
DWG NO B-WDSH-3000				

NO.	REVISION	BY	DATE

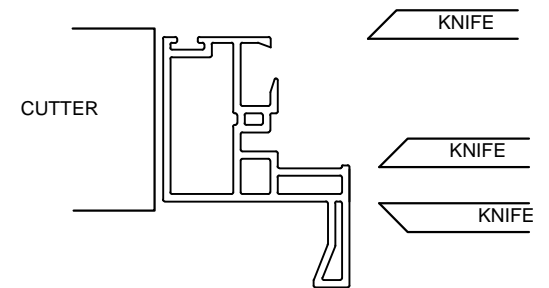
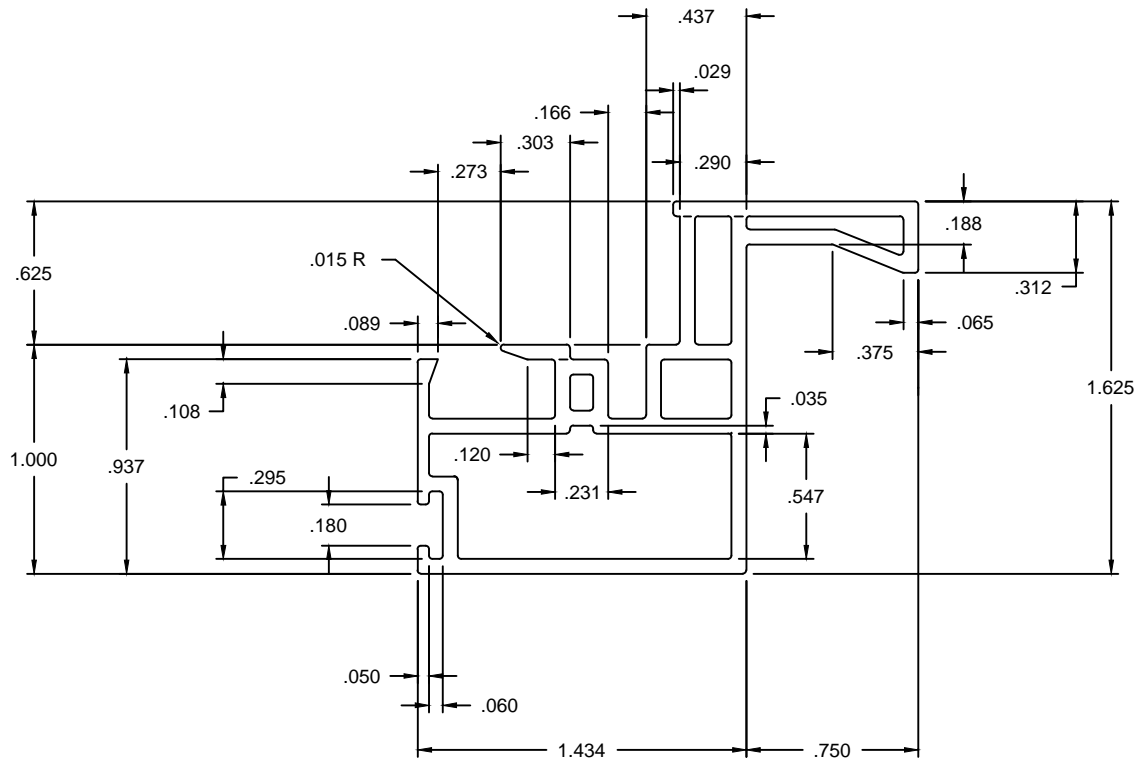

DO NOT SCALE DRAWING

☒ LOCATION FOR IMPACT TEST SPECIFICATION—LENGTHS TO 3/8"

ALLOWABLE BOW MAX. 1" PER 14' ANGULARITY TO BE ± 1/2

DRAWN FOR

QUALITY LINEALS

BY DDS DESIGNS

"OUR NAME SAYS IT ALL"

- 1) MATERIAL RIGID PVC
- 2) CAPSTOCK
- 3) UNSPECIFIED WALLS .065
- 4) BREAK ALL CORNERS .015 R
- 5) AREA .607 SQ.IN.
- 6) WT/FT LS./FT.

TITLE WELDED DOUBLE HUNG HANDLE SASH

DWN BY DDS	SCALE 2:1	DATE 11/13/02	CHKD BY	APPD BY
---------------	--------------	------------------	---------	---------

COMPUTER NO

DWG NO B-WDHS-3002

NO.	REVISION	BY	DATE

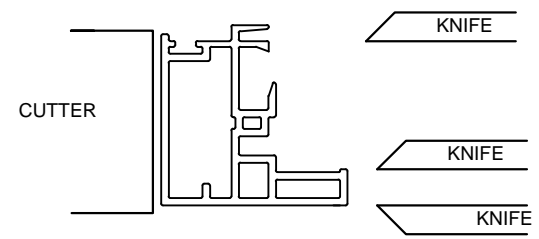
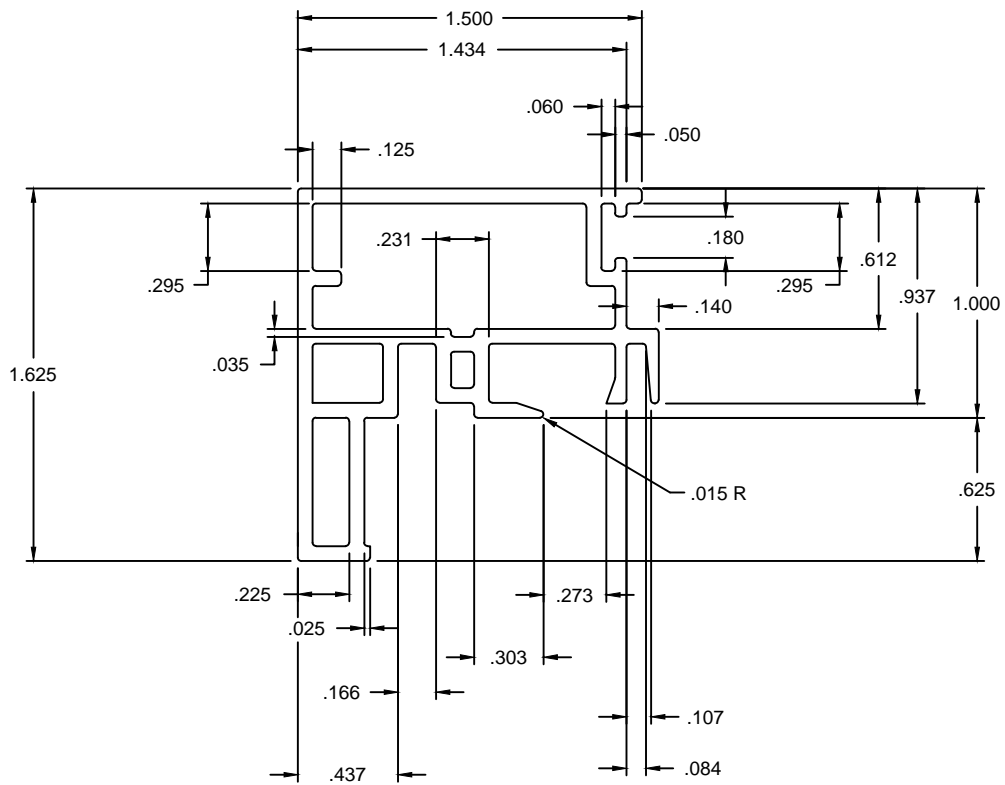

A	ADDED .125 LEG	DDS	11/28/11
NO.	REVISION	BY	DATE

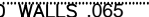
 QUALITY LINEALS BY DDS DESIGNS "OUR NAME SAYS IT ALL"	LOCATION FOR IMPACT TEST SPECIFICATION—LENGTHS TO 3/8"	ALLOWABLE BOW MAX. 1" PER 14' ANGULARITY TO BE ± 1/2	DO NOT SCALE DRAWING				
	1) MATERIAL RIGID PVC 2) CAPSTOCK  3) UNSPECIFIED WALLS .065" 4) BREAK ALL CORNERS .015" 5) AREA .529 SQ.IN. 6) WT/FT LBS./FT.	TITLE WELDED DOUBLE HUNG FEMALE DWN BY DDSR SCALE 2:1 DATE 11/13/02 CHKD BY APPD BY COMPUTER NO DWG NO B-WDIF-3003					

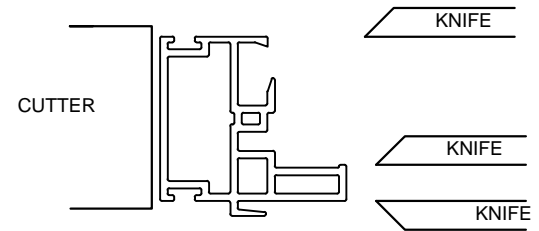
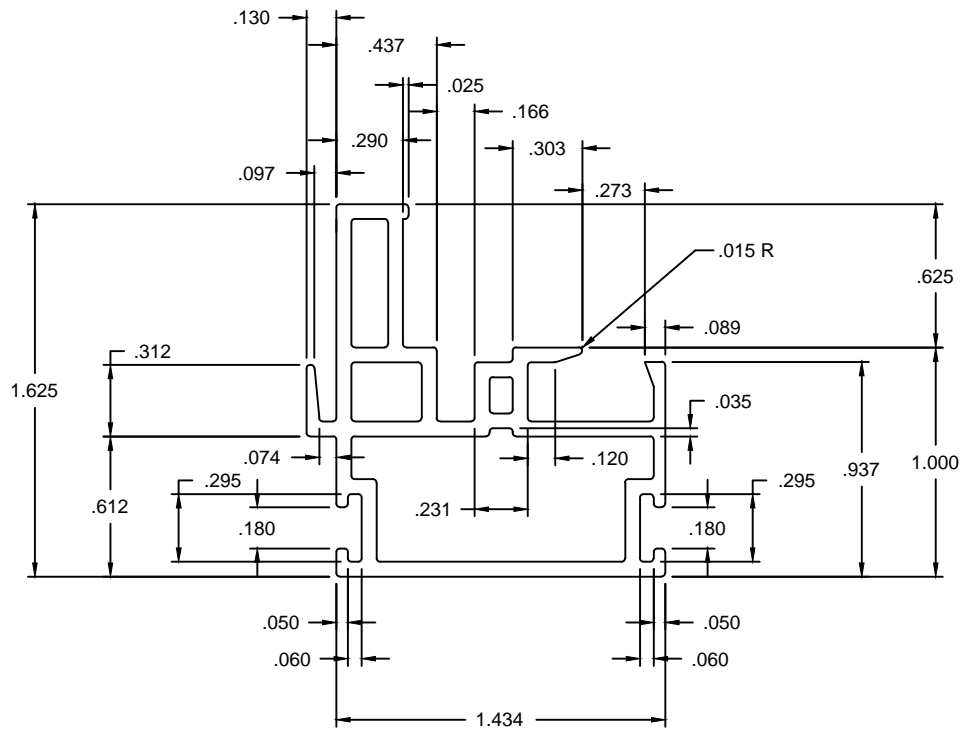

NO.	REVISION	BY	DATE

	∇ LOCATION FOR IMPACT TEST SPECIFICATION—LENGTHS TO 3/8"	ALLOWABLE BOW MAX. 1" PER 14' ANGULARITY TO BE ± 1/2	DO NOT SCALE DRAWING			
DRAWN FOR 	1) MATERIAL RIGID PVC 2) CAPSTOCK 3) UNSPECIFIED WALLS .065" 4) BREAK ALL CORNERS .015" 5) AREA .528 SQ.IN. 6) WT/FT LBS./FT.	TITLE WELDED DOUBLE HUNG MALE				
	DWN BY DDS R	SCALE 2:1	DATE 11/14/02	CHKD BY	APPD BY	
	COMPUTER NO					
	DWG NO B-WDIM-3004					
"OUR NAME SAYS IT ALL"						

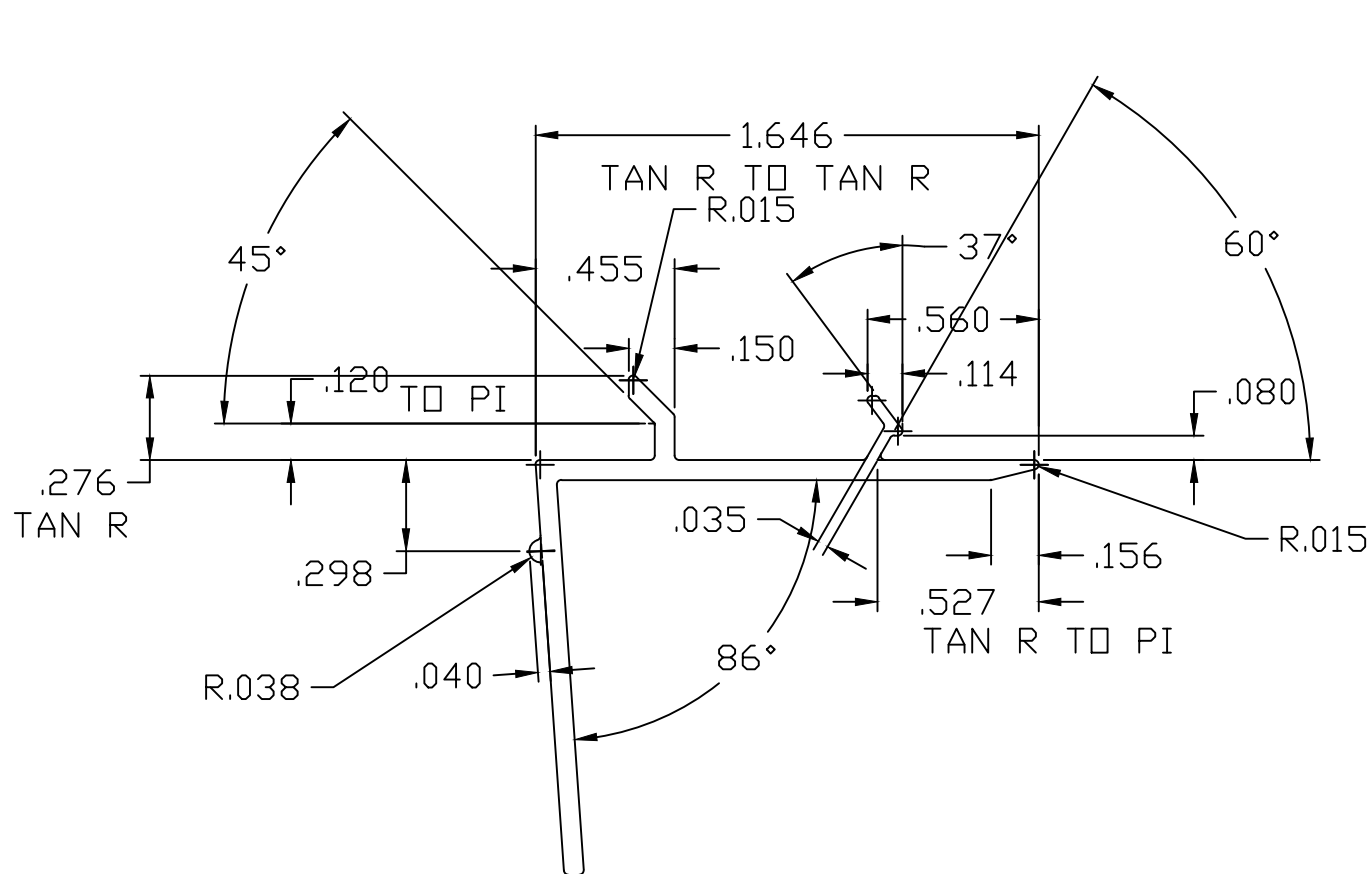

DO NOT SCALE DRAWING

☒ LOCATION FOR IMPACT TEST
SPECIFICATION—LENGTHS TO 3/8"

ALLOWABLE BOW MAX. 1" PER 14'
ANGULARITY TO BE ± 1/2

DRAWN FOR

QUALITY LINEALS

BY DDS DESIGNS

"OUR NAME SAYS IT ALL"

- 1) MATERIAL RIGID PVC
- 2) CAPSTOCK ~~XXXXXXXXXX~~
- 3) UNSPECIFIED WALLS .065
- 4) BREAK ALL CORNERS .015 R
- 5) AREA .219 SQ.IN.
- 6) WT/FT LBS/FT

TITLE WELDED DOUBLE HUNG
HEAD ADAPTER

DWN BY DDS	SCALE FULL	DATE 02 01 23	CHKD BY	APPD BY
---------------	---------------	------------------	---------	---------

COMPUTER NO

DWG NO 3005-REVISED

NO.	REVISION	BY	DATE

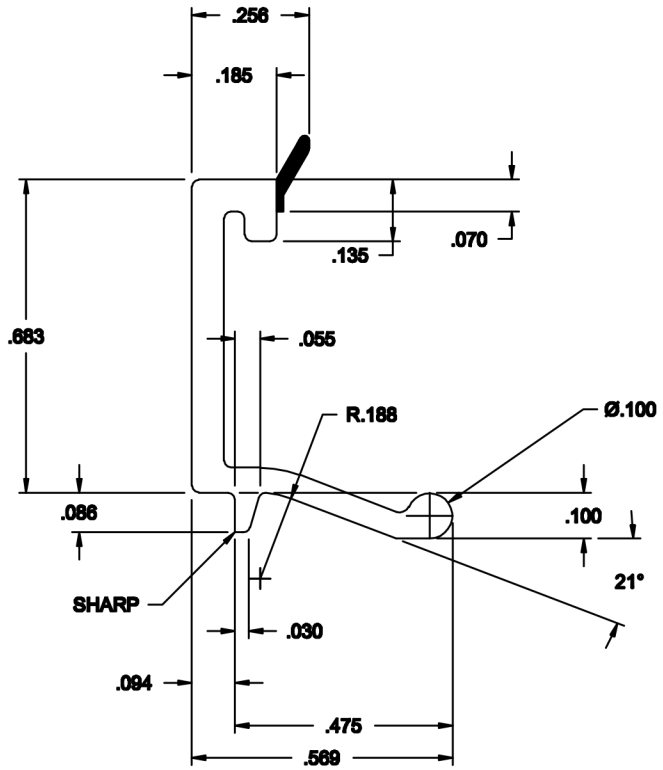
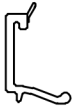

AREA OF RIGID PVC = .096
 AREA OF SOFT PVC = .004
 WT/FT OF RIGID PVC = .060
 WT/FT OF SOFT PVC = .003

DO NOT SCALE DRAWING

NO.	REVISION	BY	DATE

	LOCATION FOR IMPACT TEST SPECIFICATION-LENGTHS TO 3/8"	ALLOWABLE BOW MAX. 1" PER 14' ANGULARITY TO BE ± 1/2°	TOLERANCES- XX ± .010 XXX ± .005
	DRAWN FOR QUALITY LINEALS BY DDS DESIGNS	1) MATERIAL RIGID PVC 2) CAPSTOCK 3) UNSPECIFIED WALLS .070 4) BREAK ALL CORNERS .015 R 5) AREA .100 SQ.IN. 6) WT/FT LBS/FT	TITLE WELDED DOUBLE HUNG GLAZING BEAD DWN BY DDS SCALE 4:1 DATE 11/20/02 CHKD BY APPD BY COMPUTER NO DWG NO B-WDGB-3008