



DO NOT SCALE DRAWING

NO.	REVISION	BY	DATE

 LOCATION FOR IMPACT TEST
SPECIFICATION—LENGTHS TO 3/8"

ALLOWABLE BOW MAX. 1" PER 14'
ANGULARITY TO BE ± 1/2"

DRAWN FOR  BY  DDS DESIGNS
"OUR NAME SAYS IT ALL"

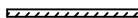
- 1) MATERIAL RIGID PVC
- 2) CAPSTOCK 
- 3) UNSPECIFIED WALLS
- 4) BREAK ALL CORNERS R
- 5) AREA SQ.IN.....
- 6) WT/FT LBS/FT.....

TITLE PW 4015 WELD MAIN FRAME				
DWN BY DDS	SCALE	DATE 01/03/12	CHKD BY	APPD BY
COMPUTER NO				
DWG NO PW4015 CROSS SECTION				

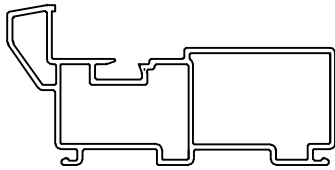

4015

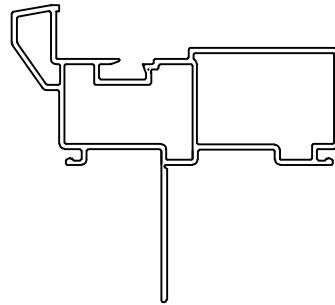

4615

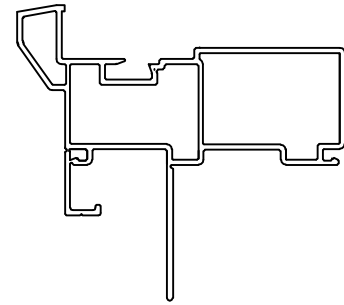

4515



3008
GLAZING BEAD
WELDED

DO NOT SCALE DRAWING

				<input checked="" type="checkbox"/> LOCATION FOR IMPACT TEST SPECIFICATION-LENGTHS TO 3/8"	ALLOWABLE BOW MAX. 1" PER 14' ANGULARITY TO BE ± 1/2°	TOLERANCES- .XX ± .010 .XXX ± .005
				DRAWN FOR  BY DDS DESIGNS "OUR NAME SAYS IT ALL"	1) MATERIAL RIGID PVC 2) CAPSTOCK 3) UNSPECIFIED WALLS 4) BREAK ALL CORNERS .015R 5) AREA SQ.IN. 6) WT/FT LBS/FT	TITLE SERIES PW 4000 PROFILE CHART DWN BY DDS SCALE DATE 11-09-11 CHKD BY APPD BY COMPUTER NO DWG NO C- PW 4000 PROFILE CHART
NO.	REVISION	BY	DATE			

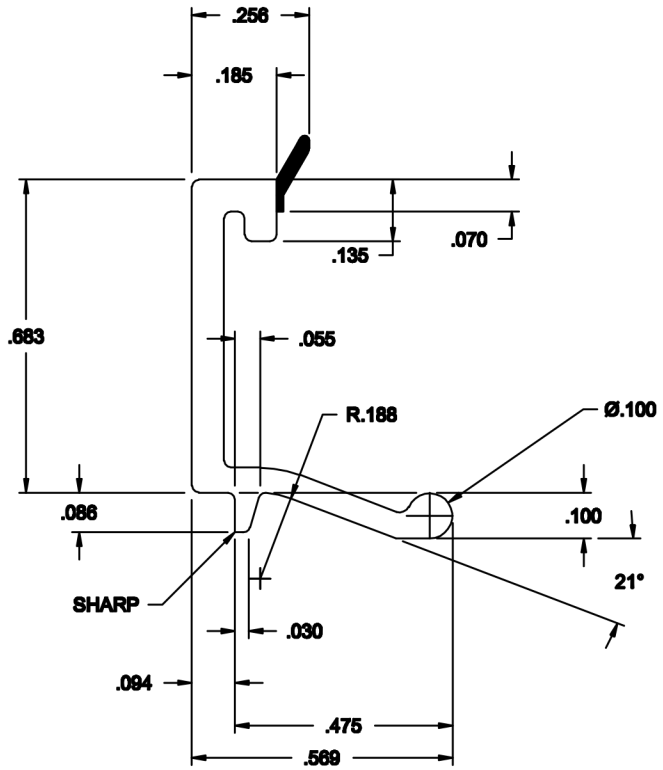
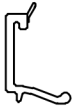

AREA OF RIGID PVC = .096
 AREA OF SOFT PVC = .004
 WT/FT OF RIGID PVC = .060
 WT/FT OF SOFT PVC = .003

DO NOT SCALE DRAWING

NO.	REVISION	BY	DATE

<p>BY DDS DESIGNS</p> <p>"OUR NAME SAYS IT ALL"</p>	LOCATION FOR IMPACT TEST SPECIFICATION-LENGTHS TO 3/8"	ALLOWABLE BOW MAX. 1" PER 14' ANGULARITY TO BE ± 1/2°	TOLERANCES- XX ± .010 XXX ± .005			
	1) MATERIAL RIGID PVC 2) CAPSTOCK 3) UNSPECIFIED WALLS .070 4) BREAK ALL CORNERS .015 R 5) AREA .100 SQ.IN. 6) WT/FT LBS/FT	TITLE WELDED DOUBLE HUNG GLAZING BEAD				
	DRAWN FOR 	DWN BY DDS	SCALE 4:1	DATE 11/20/02	CHKD BY	APPD BY
		COMPUTER NO		DWG NO B-WDGB-3008		